

ONETOUCH

UltraMini

Blood Glucose Monitoring System
Sistema de supervisión de glucosa en sangre

Just the Basics of Testing

Sólo lo básico para la realización de pruebas

**Owner's Booklet
Manual del propietario**



OneTouch® UltraMini™
Blood Glucose Monitoring System

Owner's Booklet

Welcome to the OneTouch® UltraMini™ family!

OneTouch® is committed to creating a world without limits for people with diabetes.

The OneTouch® UltraMini™ Meter makes it simple to get a test result and review past results. This owner's booklet will help you learn how to use your meter properly. Please read it carefully.

If you need assistance, please contact LifeScan Customer Service at 1 800 227-8862 (available 24 hours a day, seven days a week). Please also visit www.LifeScan.com for more information.

Table of contents

Setting up your system.....	pg. 2
Starting the test process.....	pg. 7
Getting a blood sample	pg. 10
Applying blood and reading results.....	pg. 22
Reviewing past results.....	pg. 27
Control solution testing.....	pg. 28
Caring for your system.....	pg. 33
Understanding error and other messages.....	pg. 37
Detailed information about your system.....	pg. 43
Index.....	pg. 47

Before you begin

Before using this product to test your blood glucose, carefully read this booklet and the inserts that come with the OneTouch® Ultra® Test Strips and OneTouch® Ultra® Control Solution. Take note of warnings and cautions throughout this booklet, which are identified with . Many people find it helpful to practice the test with control solution before testing with blood for the first time. See pages 28–32 in the **Control solution testing** section.

Intended use

The OneTouch® UltraMini™ Blood Glucose Monitoring System is intended to be used for the quantitative measurement of glucose (sugar) in fresh capillary whole blood. The OneTouch® UltraMini™ System is intended for use outside the body (*in vitro* diagnostic use) by people with diabetes at home and by healthcare professionals in a clinical setting as an aid to monitor the effectiveness of diabetes control. It should not be used for the diagnosis of diabetes or for testing newborns.

Test principle

Glucose in the blood sample mixes with special chemicals in the test strip and a small electric current is produced. The strength of this current changes with the amount of glucose in the blood sample. Your meter measures the current, calculates your blood glucose level, displays the result, and stores it in its memory.

The OneTouch® UltraMini™ Blood Glucose Monitoring System

To test with the OneTouch® UltraMini™ System, you will need the following:

- a. OneTouch® UltraMini™ Meter (battery included)
- b. OneTouch® Ultra® Control Solution
- c. OneTouch® Lancing Device
If another type of lancing device was included, see the separate instructions that came with that lancing device.
- d. OneTouch® AST™ Clear Cap
- e. OneTouch® UltraSoft® Sterile Lancets
- f. Carrying Case
- g. You will also need OneTouch® Ultra® Test Strips.

Some kits do not include strips.
Strips are sold separately.

Documents in your kit include this owner's booklet, a quick start guide, a quick reference guide, a control solution insert and a warranty registration card.

If any items are missing from your kit, call LifeScan Customer Service at 1 800 227-8862.

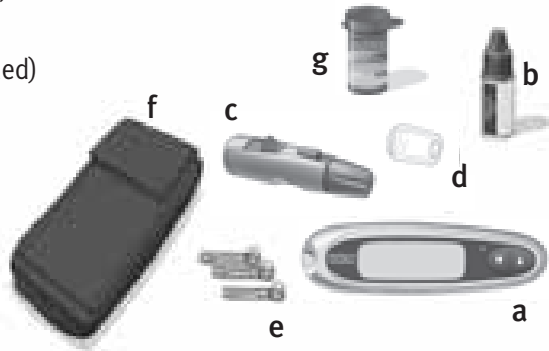

⚠ WARNING: Keep the meter and testing supplies away from young children. Small items such as the battery door, battery, test strips, lancets, protective disks on the lancets and control solution vial cap are choking hazards.

Setting up your system

Getting to know your OneTouch® UltraMini™ Blood Glucose Meter and test strips

FRONT

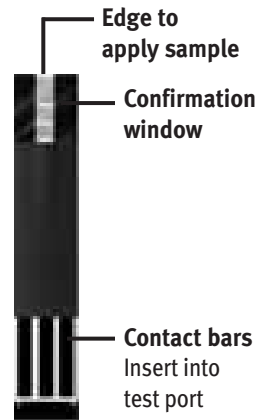
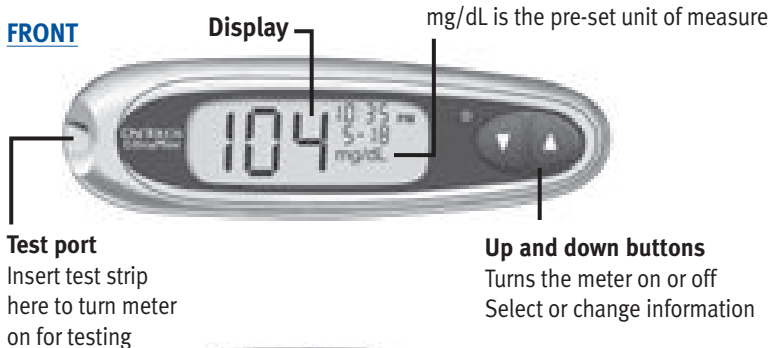

TEST STRIP

BACK

with battery door open

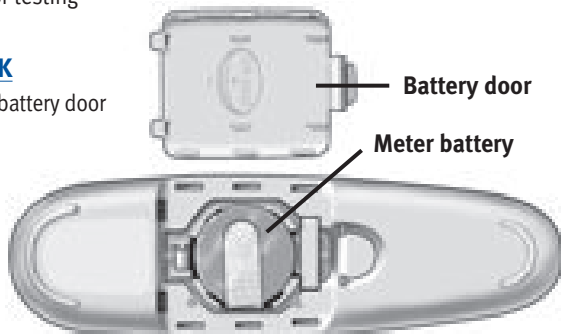

Turning your meter on

To perform a test, insert a test strip as far as it will go. The display will turn on and the meter will briefly perform system checks. **Or**, to change the time and date, start with the meter off, then press and hold ▼ for five seconds until the start-up test screen appears. After the test screen, the pre-set time and date will appear on the display. **Or**, if you want to turn the meter on to review past results, start with the meter off, then press and release ▼.

Every time you turn your meter on, a start-up test screen will appear for two seconds. All segments of the display should appear briefly on the test screen to tell you that the meter is working properly. To check that all display segments are working, as soon as the start-up test screen appears, press and hold ▲ to keep the test screen display on. Release ▲ to proceed to the next step.

If the meter does not power on, try changing the meter battery. See pages 35–36.

Turning your meter off

There are several ways to turn your meter off:

- Press and hold ▼ for two seconds, when reviewing past results.
- Your meter will turn off by itself if left alone for two minutes.
- Before or after completing a test, remove the test strip.

⚠ CAUTION: If any information is missing from the start-up test screen, there may be a problem with the meter. Call LifeScan Customer Service at 1 800 227-8862.

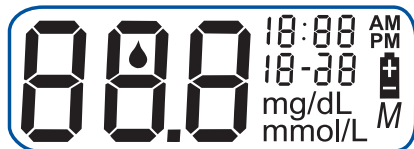

Setting the time and date

Your OneTouch® UltraMini™ Meter comes with the time, date and unit of measure pre-set. Before using your meter for the first time or if you change the meter battery, you should check and update the time and date. Make sure you complete steps 1 to 6 below to ensure your desired settings are saved.

⚠ WARNING: If your display shows mmol/L rather than mg/dL, contact LifeScan Customer Service at 1 800 227-8862. You cannot change the unit of measure. Use of the wrong unit of measure may cause you to misinterpret your blood glucose level, and may lead to incorrect treatment.

Step 1

Turn the meter on, see page 3

After the test screen, the pre-set time and date will appear on the display for five seconds.

The hour will now start flashing.

NOTE: If a setting does not need to be updated, simply wait five seconds. The meter display will automatically advance to the next setting.

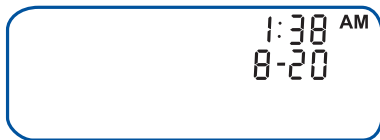

Step 2

Set the hour and “AM” or “PM”

With the hour flashing on the display, press and release ▲ or ▼ to go forward or backward one hour. To move faster, hold the ▲ or ▼ buttons down. Note that “AM” or “PM” is linked

to the hour and changes when you pass 12:00. When the correct hour appears on the display, wait five seconds. Your entry will be saved and you will move to the next setting.

STOP Check AM/PM. If not correct, continue to press ▲ or ▼ until the hour and “AM” or “PM” are correct.

You can **ONLY** change “AM” and “PM” when you pass 12:00. Make sure “AM” or “PM” is correct while you are setting the hour.

The minutes will now start flashing.

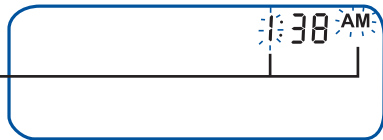

Step 3

Set the minutes

Press ▲ or ▼ to change the minutes. When you have the correct minutes on the display, wait five seconds to move to the next setting.



The year (last two digits only), month and day appear on the display and the year flashes.

Step 4

Set the year

Press ▲ or ▼ to change the year. When you have the correct year on the display, wait five seconds to move to the next setting. The month will now start flashing.

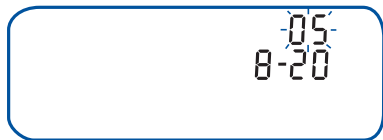

Step 5**Set the month**

Press ▲ or ▼ to change the month. When you have the correct month on the display, wait five seconds to move to the next setting.

The day will now start flashing.

**Step 6****Set the day**

Press ▲ or ▼ to change the day. When you have the correct day on the display, wait five seconds to move to the next screen.

Your time and date settings will be displayed for five seconds. After the five seconds, the settings will be saved and the meter will then turn off.

If you want to adjust your settings, press ▲ or ▼ while the time and date are still on the display. You will be returned to the first set-up screen where you can begin with the hour.

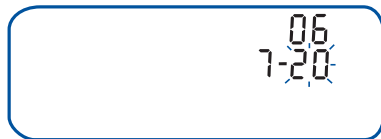

Starting the test process

Have these things ready when you test your blood glucose level:

- OneTouch® UltraMini™ Meter
- OneTouch® Ultra® Test Strips
- Lancing device
- Sterile lancets with protective disks
- OneTouch® Ultra® Control Solution

⚠ CAUTION: If you cannot test due to a problem with your testing supplies, contact your healthcare professional or LifeScan Customer Service at 1 800 227-8862. Failure to test could delay treatment decisions and lead to a serious medical condition.

NOTE:

- Use only OneTouch® Ultra® Test Strips with your OneTouch® UltraMini™ Meter.
- Make sure your meter and test strips are about the same temperature before you test.
- Testing must be done within the operating temperature range (43–111°F). For the most accurate results, try to test as close to room temperature (68–77°F) as you can.
- You can perform a blood glucose test while your OneTouch® UltraMini™ Meter is inside its case.

Step 1

Check the code on the test strip vial before inserting the strip

Code numbers are used to calibrate your meter with the test strips you are using to obtain accurate test results. You must code the meter before using it for the first time and then every time you change to another vial of test strips.



⚠ CAUTION: The test strip vial contains drying agents that are harmful if inhaled or swallowed and may cause skin or eye irritation.

Step 2

Insert a test strip to turn on the meter

Start with the meter off. If you have turned the meter on to change settings or review past results, turn it off. Remove a test strip from its vial. With clean, dry hands, you may touch the test strip anywhere on its surface. Do not bend, cut or modify the test strips in any way. Use each test strip immediately after removing it from the vial.

Hold the meter as shown and insert the test strip into the test port. Make sure the three contact bars are facing you. Push the strip in as far as it will go. Do not bend the strip.

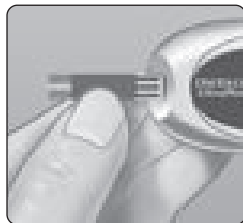

⚠ CAUTION: OneTouch® Ultra® Test Strips are for single use only. Never re-use a strip that had either blood or control solution applied to it.

After the start-up test screen appears, the meter will display the code from your last test. If a constant \square and a flashing “—” appear instead of a code number, such as when you are first using the meter, follow the instructions on the next page to change to a numerical code.

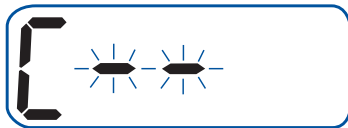

Step 3

Match the code on the meter with the code on the test strip vial

If the code on the meter does not match the code on the test strip vial, press ▲ or ▼ to match the code number on the test strip vial. The new code number will flash on the display for three seconds, and then stay constant for three seconds.

The display will advance to the screen with the flashing blood drop icon 🩸.

If the codes already match, wait three seconds. The display will advance to the screen with the flashing blood drop icon 🩸.

The meter is now ready to perform a blood glucose test.

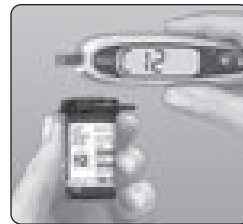

mg/dL

NOTE:

- If the screen with the flashing blood drop icon 🩸 appears before you are sure the codes match, remove the test strip, wait until the meter turns off, then re-start from step 1, see page 7.
- If you press ▲ by mistake so that the control solution test symbol **CtL** appears on the display, press ▲ again to change it back to the screen with the flashing blood drop icon 🩸.

⚠ CAUTION: Matching the code on the meter and the code on the test strip vial is essential to obtain accurate results. Each time you test, check to make sure the code numbers match.

Overview of the OneTouch® Lancing Device

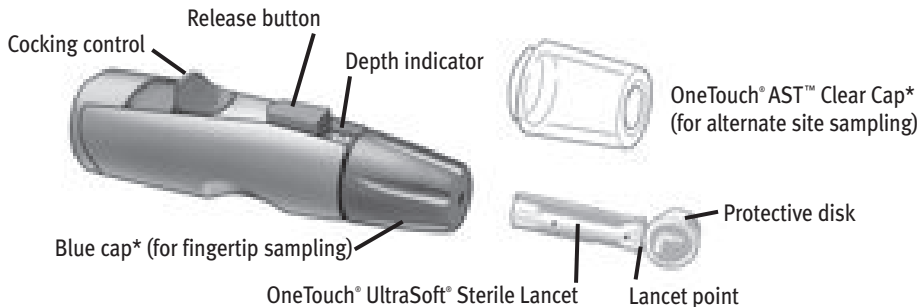

**The blue cap and OneTouch® AST™ Clear Cap are also used for depth adjustment*

NOTE: If you do not have a OneTouch® Lancing Device, please refer to the instructions that came with your lancing device.

⚠ CAUTION: To reduce the chance of infection:

- Make sure to wash the puncture site with soap and water before sampling.
- Never share a lancet or a lancing device with anyone.
- Always use a new, sterile lancet—lancets are for single use only.
- Keep your meter and lancing device clean. See page 34.

Choosing the right sampling site at the right time

The OneTouch® UltraMini™ Meter allows you to sample blood from your fingertip, forearm or palm. Forearm and palm sampling is also referred to as “alternate site testing” (AST). At times, results obtained at the forearm or palm may be different from a fingertip measurement. Talk to your healthcare professional before you begin using your forearm or palm for sampling.

If you are testing:	Use blood sample from your:
Routinely before meals Prior to or more than two hours after: <ul style="list-style-type: none"> • a meal • a rapid-acting insulin injection or insulin pump bolus • exercise 	Fingertip, forearm, or palm
When your blood glucose is changing rapidly, such as: <ul style="list-style-type: none"> • within two hours after a meal • within two hours after a rapid-acting insulin injection or insulin pump bolus, or • during or within two hours after exercise When you are concerned about the possibility of hypoglycemia (low blood sugar)	Fingertip

 **CAUTION: Do not** test on your forearm or palm when:

- You think your blood glucose is rapidly falling, such as within two hours of exercise or a rapid-acting insulin injection or insulin pump bolus. Testing with a fingertip sample may identify hypoglycemia or an insulin reaction sooner than testing with a forearm or palm sample.
- It has been less than two hours after a meal, a rapid-acting insulin injection or insulin pump bolus, physical exercise, or you think your glucose level is changing rapidly.
- You are concerned about the possibility of hypoglycemia or an insulin reaction, such as when driving a car. This is especially important if you suffer from hypoglycemia unawareness (lack of symptoms to indicate an insulin reaction).

Remember: Consult with your healthcare professional before using your forearm or palm for testing.

Choose a different puncture site each time you test. Repeated punctures in the same spot may cause soreness and calluses.

If bruising occurs at an alternate site or you have difficulty getting a sample, consider sampling from a fingertip instead. You may want to review the choice of sites with your healthcare professional.

Preparing your sample site

Before you test your blood glucose, wash your hands and forearm (if applicable) thoroughly with warm, soapy water. Rinse and dry.

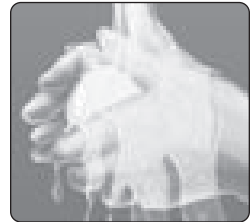

Lancing and sampling from your fingertip

Step 1

Remove the blue cap by snapping it off

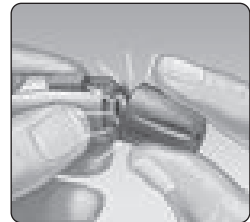

Step 2**Insert a sterile lancet into the OneTouch® Lancing Device**

Insert the lancet into the holder and push in firmly. Twist the protective disk until it separates from the lancet and save the disk for later use. Do not twist the lancet.

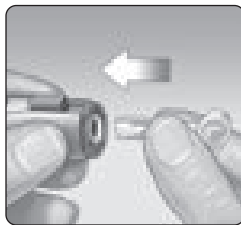
**Step 3****Replace the blue cap by snapping it back on****Step 4****Adjust the depth setting**

The OneTouch® Lancing Device has nine puncture depth settings, numbered 1 through 9. The smaller numbers are for a shallower puncture, and the larger numbers are for a deeper puncture. Shallower punctures work for children and most adults. Deeper punctures work well for people with thick or callused skin. Twist the blue cap until the correct setting appears.

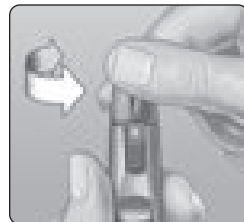

NOTE: A shallower puncture may be less painful. Try a shallower setting first and increase the depth until you find the one deep enough to get a blood sample of at least one microliter (● actual size).

Step 5

Cock the OneTouch® Lancing Device

Slide the cocking control back until it clicks. If it does not click, it may have been cocked when you inserted the lancet.



Step 6

Puncture your finger

Hold the OneTouch® Lancing Device firmly against the side of your finger. Press the release button. Remove the OneTouch® Lancing Device from your finger.

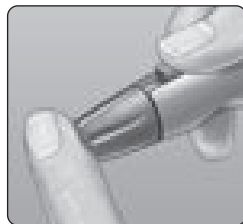

Step 7**Get a round drop of blood**

Gently squeeze and/or massage your fingertip until a round drop of blood **of at least one microliter (● actual size)** forms on your fingertip.



If the blood smears or runs, do not use that sample. Wipe the area and gently squeeze another drop of blood or puncture a new site.

**Lancing and sampling from an alternate site**

Sampling from your palm or forearm allows you to use your fingertips less often. You may find that obtaining a blood sample from an alternate site is less painful than using a fingertip. Getting a blood sample from your forearm or palm is different than getting a sample from your fingertips.

Forearm sampling

Choose a fleshy area of the forearm away from bone, visible veins and hair. Sometimes there is less blood flow to the forearm than to the fingertips. To help you get a large enough drop of blood, you may gently massage or apply warmth to the site to increase blood flow.

**Forearm*****Palm sampling***

Choose a fleshy area on the palm below your thumb or little pinky finger. Select a spot with no visible veins and away from deep lines, which may cause your blood sample to smear.

**Palm**

Blue cap
for fingertip
sampling
only

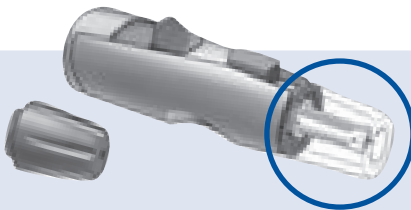

The OneTouch® AST™ Clear Cap is used for forearm and palm sampling only. Replace the blue cap with the OneTouch® AST™ Clear Cap.

Step 1

Remove the blue cap by snapping it off



Step 2

Insert a sterile lancet into the OneTouch® Lancing Device

Insert the lancet into the holder and push in firmly. Twist the protective disk until it separates from the lancet and save the disk for later use. Do not twist the lancet.

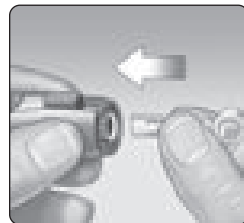

Step 3

Install the OneTouch® AST™ Clear Cap on the OneTouch® Lancing Device by snapping it on

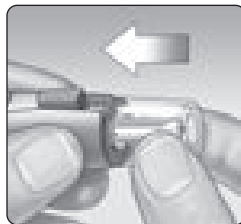
**Step 4**

Adjust the depth setting

You may have to adjust the OneTouch® Lancing Device to a deeper setting to get a large enough drop of blood from your forearm or palm. Twist the OneTouch® AST™ Clear Cap toward the larger numbers to increase the depth.

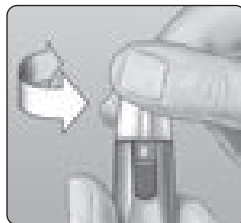
**Step 5**

Cock the OneTouch® Lancing Device

Slide the cocking control back until it clicks. If it does not click, it may have been cocked when you inserted the lancet.



Step 6**Puncture your forearm or palm**

Firmly press and hold the lancing device against your forearm or palm for a few seconds. **Wait until the skin surface under the OneTouch® AST™ Clear Cap changes color (as blood collects beneath the skin). This tells you there is enough blood flow for a good sample.** Then press the release button while continuing to apply pressure. Keep holding the lancing device against your skin until a round drop of blood forms under the cap.

When sampling blood from your forearm or palm, make sure the drop of blood is **of at least one microliter (● actual size)** before you release pressure and remove the lancing device.



**Forearm****Palm****Step 7****Remove the OneTouch® Lancing Device**

Carefully lift the lancing device away from your skin. Do not smear the blood sample.

NOTE:

- You may need to wait a little longer to get a large enough drop of blood from the forearm or palm. **Do not** squeeze the site excessively.
- If the sample drop of blood runs or spreads due to contact with hair or with a line in your palm, **do not** use that sample. Try puncturing again in a smoother area.
- Remember: You may have to adjust the lancing device to a deeper setting to get a large enough drop of blood (● actual size).

Applying blood and reading results

Once you have a blood sample and your meter shows the screen with the flashing blood drop icon , you are ready to obtain a blood glucose result. If your meter does not show the screen with the flashing blood drop icon , remove the unused test strip and re-start the test process. See page 7.

Step 1

Prepare to apply the sample

The drop of blood should be next to the top edge of the test strip. **Blood should not be applied to the flat surface of the test strip.**

When applying a drop of blood from your forearm or palm, keep your palm or forearm steady and bring the top edge of the test strip to the drop of blood with your other hand.

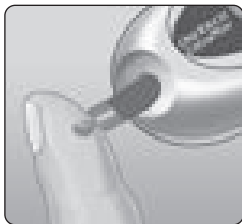

Fingertip



Forearm



Palm

Step 2

Apply the sample

Touch and hold the drop of blood to the narrow channel in the top edge of the test strip. Blood will be drawn into the strip. Keep holding the drop of blood to the top edge of the test strip until the confirmation window is full.

NOTE:

- **Do not** smear or scrape the drop of blood with the test strip.
- **Do not** press the test strip too firmly against your puncture site.
- **Do not** apply more blood to the test strip after you have moved the drop of blood away.
- **Do not** move the test strip in the meter during a test.

Top edge



Narrow channel
Apply drop here



Step 3

Read your result

When the meter detects blood in the test strip, it begins to count down from 5 to 1. Then, your blood glucose level appears on the display, along with the unit of measure, and the date and time of the test. Blood glucose results are automatically stored in the meter's memory.

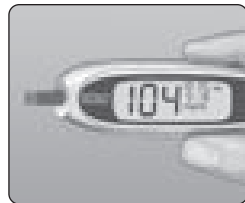

⚠ CAUTION: If you test at the low end of the operating range (43°F) and your glucose is high (over 180 mg/dL), the reading on your meter may be lower than your actual glucose. In this situation, repeat the test in a warmer environment with a new test strip as soon as possible.

⚠ CAUTION: You may get an **Er 5** message or an inaccurate result if the blood sample does not fill the confirmation window completely. See page 42. Discard the strip and re-start the test process.

⚠ WARNING: If mg/dL does not appear with the test result, call LifeScan Customer Service at 1 800 227-8862. Use of the wrong unit of measure may cause you to misinterpret your blood glucose level, and may lead to incorrect treatment.

Error messages

If you get an **Er** message on your screen rather than a result, see pages 37–42.

Unexpected test results

Refer to these cautions **⚠** whenever your results are lower than, higher than, or otherwise not what you expect.

⚠ CAUTION: Dehydration and low glucose results

Severe dehydration resulting from excessive water loss may cause false low results. If you think you are suffering from severe dehydration, contact your healthcare professional immediately.

⚠ CAUTION: Low glucose results

If your test result is lower than 70 mg/dL or is shown as LO, it may mean hypoglycemia (low blood glucose). This may require immediate treatment according to your healthcare professional's recommendations. Although this result could be due to a test error, it is safer to treat first, then do another test.

⚠ CAUTION: High glucose results

If your test result is higher than 180 mg/dL, it may mean hyperglycemia (high blood glucose). If you are uncertain about this test result, consider re-testing. Your healthcare professional can work with you to determine what actions, if any, you should take if your results are higher than 180 mg/dL.

If your meter displays HI, you may have a very high blood glucose level (severe hyperglycemia) exceeding 600 mg/dL. Re-check your glucose level. If the result is HI again, this may indicate a severe problem with your blood glucose control and it is important you obtain and follow instructions from your healthcare professional without delay.

⚠ CAUTION: Repeated unexpected glucose results

If you continue to get unexpected results, check your system with control solution. See Control solution testing, pages 28–32.

If you are experiencing symptoms that are not consistent with your blood glucose results and you have followed all instructions in this booklet, call your healthcare professional. Never ignore symptoms or make significant changes to your diabetes control program without speaking to your healthcare professional.

⚠ CAUTION: Unusual red blood cell count

A hematocrit (percentage of your blood that is red blood cells) that is either very high (above 55%) or very low (below 30%) can cause false results.

After getting a result

Once you have read your result, you may:

- Review your meter memory by pressing ▼ to enter memory mode, see page 27, or
- Turn the meter off by removing the test strip.

Removing the used lancet

Remove the lancing device cap by snapping it off. **Cover the exposed lancet tip before removing the lancet.** Place the lancet protective disk on a hard surface. Push the lancet tip into the disk. Remove the lancet and place it in a container for sharp objects. Replace the cap.

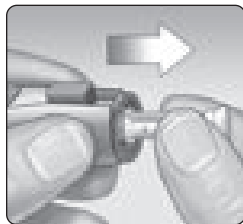

Disposing of the used lancet and test strip

It is important to discard the used lancet carefully after each use to avoid unintended lancet stick injuries. Used test strips and lancets may be considered biohazardous waste in your area. Be sure to follow your local regulations for proper disposal.

Reviewing past results

The meter stores a maximum of 50 blood glucose test results. When the meter memory is full, the oldest result is dropped as the newest is added. Results are stored automatically when you test, along with the time, date and unit of measure. You can review the results stored in the meter memory, starting with the most recent.

If your meter is off, press and release ▼ to turn it on. After the start-up test screen, your most recent test result will appear on the display. “M” also appears to indicate memory mode.

If you have just completed a test, leave the test strip in the meter and press ▼ to enter the memory mode. Your most recent blood glucose test result appears along with “M”.

Press ▼ to move to the previous result stored in the meter. Then, press ▲ or ▼ to move forward or backward through all of your results. When you’re finished reviewing past results, press and hold ▼ for two seconds until the meter turns off.



NOTE: If no results are currently stored in the meter, “----” will appear on the display.

Control solution testing

OneTouch® Ultra® Control Solution contains a known amount of glucose and is used to check that the meter and the test strips are working properly.

Do a control solution test:

- to practice the test process instead of using blood,
- once a week,
- whenever you open a new vial of test strips,
- if you suspect the meter or test strips are not working properly,
- if you have had repeated unexpected blood glucose results (as described on page 25), or
- if you drop or damage the meter.

NOTE:

- Use only OneTouch® Ultra® Control Solution with your OneTouch® UltraMini™ Meter.
- Control solution tests must be done at room temperature (68–77°F). Make sure your meter, test strips, and control solution are at room temperature before testing.

⚠ CAUTION: Do not swallow control solution; it is not for human consumption.
Do not apply control solution to the skin or eyes as it may cause irritation.

Performing a control solution test

Start with the meter off. If you have turned the meter on to change settings or review past results, turn it off.

Step 1

Check the code on the test strip vial before inserting the strip



Step 2

Insert a test strip to turn on the meter

Make sure the three contact bars are facing you. Push the strip in as far as it will go. Do not bend the strip.

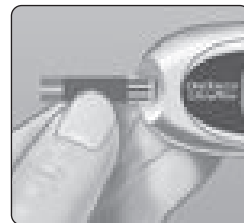

Step 3**Match the code on the meter with the code on the test strip vial**

If the code on the meter does not match the code on the test strip vial, press ▲ or ▼ to match the code number on the test strip vial. The new code number will flash on the display for three seconds, and then stay constant for three seconds. The display will advance to the screen with the flashing blood drop icon 🩸.



If the codes already match, wait three seconds. The display will advance to the screen with the flashing blood drop icon 🩸.

Step 4**Mark the test as a control solution test****IMPORTANT:**

- Mark all control solution tests with **CtL**. This will stop them from being stored as blood glucose results.
- Control solution results marked with **CtL** are not stored in the meter's memory.



mg/dL



[CtL

mg/dL

Press ▲ so that the control solution test symbol **CtL** appears in the upper right corner of the display. You must mark the test before you apply control solution. Once you have completed the test, you cannot change the marking. The meter is now ready to perform a control solution test.

If you decide not to do a control solution test, press ▲ again to remove **CtL** from the display.

Step 5

Prepare and apply control solution

Shake the control solution vial before each test. Remove the cap and squeeze the vial to discard the first drop. Then wipe the tip with a clean tissue or cloth. Hold the vial upside down and gently squeeze a hanging drop.

Touch and hold the hanging drop of control solution to the narrow channel in the top edge of the test strip. Make sure the confirmation window fills completely. Control solution should not be applied to the flat face of the test strip.

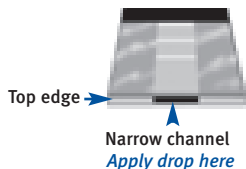

Step 6

Read your result

When the meter detects control solution in the test strip, it begins to count down from 5 to 1.

Your result will then appear on the display, along with **CtL** and the unit of measure.



Step 7

Check if the result is in range

Compare the result displayed on the meter to the control solution range printed **on the test strip vial**. Each vial of test strips may have a different control solution range. If the results you get are not within this range, the meter and strips may not be working properly. Repeat the control solution test.

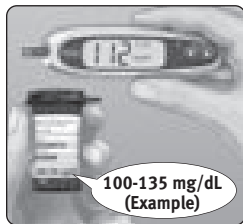

Out-of-range results may be due to:

- not following the instructions detailed on pages 29–31,
- expired or contaminated control solution,
- expired or damaged test strip,
- use of a test strip or control solution past its discard date, or
- a problem with the meter.

⚠ CAUTION: The control solution range printed on the test strip vial is for OneTouch® Ultra® Control Solution only. It is not a recommended range for your blood glucose level.

⚠ CAUTION: If you continue to get control solution results that fall outside the range printed on the test strip vial, do not use the meter, the test strips, or the control solution. Call LifeScan Customer Service at 1 800 227-8862.

Caring for your system

Your OneTouch® UltraMini™ Blood Glucose Monitoring System does not need any special maintenance.

Storing your system

Store your meter, strips and control solution in your carrying case after each use. Store each item in a cool, dry place below 86°F, but do not refrigerate. Keep all items away from direct sunlight and heat.

Tightly close the cap on the test strip vial and/or control solution vial immediately after use to avoid contamination or damage. Store test strips only in their original vial.

Checking for expiration or damage to strips and control solution

Test strips and control solution have expiration dates printed on their vials. When you first open a test strip or control solution vial, you must record the discard date (date opened plus three months) in the space provided on the label.

 **CAUTION: Do not** use the strips or control solution after the expiration date printed on the vial or the discard date, whichever comes first, or your results may be inaccurate.

⚠ CAUTION: Do not use your test strips if your vial is damaged or left open to air. This could lead to error messages or tests that read higher than the actual value. Call LifeScan Customer Service at 1 800 227-8862 immediately if the test strip vial is damaged.

Cleaning your meter

To clean your meter, wipe the outside with a soft cloth dampened with water and mild detergent. Do not use alcohol or another solvent to clean your meter.

Do not get any liquids, dirt, dust, blood, or control solution inside the meter through the test port. Never spray cleaning solution on the meter or immerse it in any liquid.

Cleaning your OneTouch® Lancing Device and OneTouch® AST™ Clear Cap

To clean these items, wipe them with a soft cloth dampened with water and mild detergent. Do not immerse the OneTouch® Lancing Device in any liquid.

To disinfect these items, prepare a solution of one part household bleach to ten parts water. Wipe the OneTouch® Lancing Device with a soft cloth dampened with this solution. Immerse the **caps only** in this solution for 30 minutes. After disinfecting, rinse briefly with water and allow both to air dry.

Battery

Your OneTouch® UltraMini™ Meter uses one 3.0 Volt CR 2032 lithium battery (or equivalent). Replacement batteries can be found in most stores where batteries are sold. Your meter comes with the battery already installed.

The meter shows a battery icon  in the far right-hand side of the display to indicate the condition of the battery.

When the battery icon first appears along with the unit of measure, there is enough power for a minimum of 100 more tests. You should replace the battery as soon as possible.



When the battery icon appears by itself, there is not enough battery power remaining to perform a test. You must install a new battery before using your meter.



Replacing the battery

Step 1

Remove the old battery

Start with the meter off. Open the battery door and pull up on the battery ribbon.

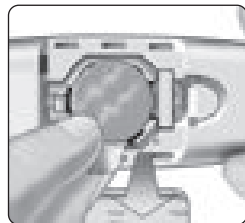

Step 2

Insert the new battery

With the “+” side facing up toward you, place the battery in the compartment within the fold of the ribbon. Push the battery until it snaps into place. Insert the two battery door tabs into the matching holes, and push down until you hear the door click into place.

If the meter does not power on after you have replaced the battery, check that the battery is correctly installed with the “+” side up. If the meter still does not power on, call LifeScan Customer Service at 1 800 227-8862.

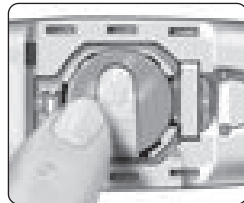

Step 3

Check the time and date

After replacing the battery, turn the meter on by pressing and holding the ▼ button for five seconds to access the set-up mode. The start-up test screen will be briefly displayed; then the date and time will appear in the top right corner of the display. Check that the time and date are set correctly. If they are not, use the ▲ and ▼ buttons to re-set the meter before testing. See Setting the time and date, pages 4–6.



NOTE: Removing the meter battery will **NOT** affect your stored results. However, you may need to re-set the time and date.

Step 4

Dispose of batteries according to your local environmental regulations

Understanding error and other messages

The OneTouch® UltraMini™ Meter displays messages when there are problems with the test strip, with the meter, or when your blood glucose levels are higher than 600 mg/dL or lower than 20 mg/dL. Messages do not appear in all cases when a problem has occurred. Improper use may cause an inaccurate result without producing a warning message.

Message	What it means	What to do
	You may have a very low blood glucose level (severe hypoglycemia), lower than 20 mg/dL.	This may require immediate treatment according to your healthcare professional's recommendations. Although this message could be due to a test error, it is safer to treat first and then do another test.
	You may have a very high blood glucose level (severe hyperglycemia), over 600 mg/dL.	Re-check your glucose level. If the result is HI again, obtain and follow instructions from your healthcare professional without delay.

Message

What it means

What to do



The meter has detected that the temperature is above the system operating range. **Do not** perform a test until the meter and test strips reach a temperature within the operating range of 43–111°F.

Repeat the test after the meter and test strips have reached a temperature within the operating range.



The meter has detected that the temperature is below the system operating range. **Do not** perform a test until the meter and test strips reach a temperature within the operating range of 43–111°F.

Repeat the test after the meter and test strips have reached a temperature within the operating range.

Message

What it means

What to do

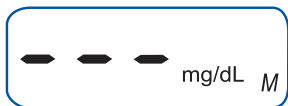

No result in memory, such as the first time use of the meter.
or,
Your meter was unable to recall this result.

You can still perform a blood glucose test and get an accurate test result. Contact LifeScan Customer Service at 1 800 227-8862 to report this occurrence if this is **not** your first time use of the meter.



Error message indicates there is a problem with the meter.

Do not use the meter. Contact LifeScan Customer Service at 1 800 227-8862.



Error message could be caused either by a used test strip or a problem with the meter.

Repeat the test with a new test strip; see pages 22–23. If this message continues to appear, contact LifeScan Customer Service at 1 800 227-8862.

Message

What it means

What to do



Error message indicates that the blood or control solution sample was applied before the meter was ready.

Repeat the test with a new test strip. Apply a blood or control solution sample only after the flashing blood drop icon  appears on the display. If this message continues to appear, contact LifeScan Customer Service at 1 800 227-8862.



One of the following may apply:

You may have high glucose and have tested in an environment near the low end of the system's operating temperature range (43–111°F).
or,

If you tested in a cool environment, repeat the test in a warmer environment with a new test strip; see pages 22–23. If this error message appears again, contact LifeScan Customer Service at 1 800 227-8862.

see top of next page

Message

What it means

What to do



There may be a problem with the test strip. For example, it may have been damaged or moved during testing.
or,

The sample was improperly applied.
or,

There may be a problem with the meter.

If you tested in a normal or warm environment, repeat the test with a new test strip; see pages 22–23. If this error message appears again, contact LifeScan Customer Service at 1 800 227-8862.

If you applied the blood incorrectly, review pages 22–23 on blood application and repeat the test with a new test strip. If the error message appears again, contact LifeScan Customer Service at 1 800 227-8862.

If this error message appears again, contact LifeScan Customer Service at 1 800 227-8862.

Message

What it means

What to do



The meter has detected a problem with the test strip. Possible causes are test strip damage or an incompletely filled confirmation window.

Repeat the test with a new test strip. Refer to pages 22–23 for information on sample application.



Meter battery is low but there is enough power to perform a test.

When the battery icon first appears, there is enough power for a minimum of 100 more tests. Test results will still be accurate, but replace the battery as soon as possible.

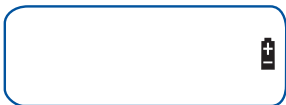

The  symbol appears on the display by itself when the meter battery does not have enough power to perform a test.

Replace the meter battery.

Comparing meter and laboratory results

Test results with the OneTouch® UltraMini™ Meter are plasma-calibrated. This helps you and your healthcare professional to compare your meter results with laboratory tests. If you have been using another type of meter—one that provides whole-blood-calibrated results—you may notice that your test results with the OneTouch® UltraMini™ Meter are approximately 12% higher.

OneTouch® UltraMini™ Meter test results and laboratory test results both are expressed in plasma-equivalent units. However, your meter result may differ from your laboratory result due to normal variation. Meter results can be affected by factors and conditions that do not affect laboratory results in the same way.

Your OneTouch® UltraMini™ Meter glucose value is considered accurate when it is within $\pm 20\%$ of the laboratory measurement. There are some specific situations that could cause a difference of more than $\pm 20\%$:

- You have eaten recently. The blood glucose level from a finger stick can be up to 70 mg/dL higher than blood drawn from a vein (venous sample) used for a lab test.¹

1. Sacks, D.B.: “Carbohydrates.” Burtis, C.A., and Ashwood, E.R. (ed.), *Tietz Textbook of Clinical Chemistry*. Philadelphia: W.B. Saunders Company (1994), 959.

- Your hematocrit (percentage of blood that is red blood cells) is high (above 55%) or low (below 30%).
- You are suffering from severe dehydration.
- You tested at a temperature near the low end of the operating range (43°F) and you get a high glucose result (i.e., greater than 180 mg/dL). In this situation, repeat the test in a warmer environment with a new test strip as soon as possible.

For accuracy and precision data and for important information on limitations, see the insert that comes with your test strips.

To maximize your chances of an accurate comparison between meter and laboratory results, follow a few basic guidelines:

Before going to the lab

- Perform a control solution test to make sure the meter is working properly.
- Do not eat for at least eight hours before you test your blood.
- Take your meter with you to the lab.

While at the lab

- Conduct your meter test within 15 minutes of the lab test.
- Use only fresh, capillary blood obtained from the fingertip.
- Follow all instructions in this owner's booklet for performing a blood glucose test with your meter.

Technical specifications

Reported result range	20–600 mg/dL
Calibration	Plasma-equivalent
Sample	Fresh capillary whole blood
Sample size	Minimum 1 microliter
Test time	5 seconds
Assay method	Glucose oxidase biosensor
Meter power source	One replaceable 3.0 Volt CR 2032 lithium battery (or equivalent)
Unit of measure	mg/dL
Memory	50 blood glucose test results
Automatic shutoff	2 minutes after last action
Size	4.25 x 1.26 x .67 inches
Weight	Approximately 1.2 ounces, with battery
Operating ranges	Temperature: 43–111°F • Altitude: up to 10,000 feet Relative humidity: 10–90% • Hematocrit: 30–55%

Battery ratings

One 3.0 V d.c., 3 mA (one CR 2032 battery)

 direct current

Symbols



Cautions and Warnings: Refer to safety-related notes in the owner's booklet and inserts that came with your meter and testing supplies.



Low battery



Direct current

Electrical and safety standards

The meter has been tested for immunity to Level 4 electrostatic discharge as specified in IEC 61000-4-2. This meter has been tested for immunity to radio frequency interference over the frequency range 80MHz to 2.5GHz at 3V/m as specified in IEC 61000-4-3.

Degree of protection rating: IP32

Guarantee

LifeScan guarantees that the OneTouch® UltraMini™ Meter will be free of defects in material and workmanship for three years, valid from the date of purchase. The guarantee extends only to the original purchaser and is not transferable.

Index

Alternate site testing procedure	16	Fingertip testing procedure	13
Battery	2, 35	Forearm	11, 17, 20, 22
Battery, icon on display	35, 42	Forearm or palm sampling, important information	11, 12, 21
Buttons on meter	2	Guarantee	46
Cleaning your meter and lancing device	34	HI (high glucose) message	25, 37
Code	7, 29	Hyperglycemia	25
Confirmation window	2, 23, 31	Hypoglycemia	11, 12, 24
Control solution	1, 28	Infection, reduce the risk	10
Control solution, result range	32	Intended use	iv
Control solution, storing	33	Lab results, comparing with meter results	43
Control solution, testing	28	Lancet, disposal	26
Date setting	5, 6	Lancet, inserting in lancing device ...	14, 18
Dehydration	24	Lancet, protective disk	10, 14, 18, 26
Discard date, control solution	33	Lancing device and cap	10, 13
Discard date, test strips	33	Lancing device, OneTouch® AST™ Clear Cap	10, 18, 19
Drop of blood, proper size	16, 20, 21	Lancing device, depth setting ...	10, 14, 19
Er (Error) messages	24, 37	LO (low glucose) message	24, 37
Expiration date, control solution	33		
Expiration date, test strips	33		

Low battery icon	35, 42	Test screen	3, 8
Low battery message	35, 42	Test strip, applying drop of blood	2, 22
mg/dL	4, 24, 45	Test strip, confirmation window	2, 23, 31
mmol/L	4	Test strip, contact bars	2, 8, 29
Palm	11, 17, 20, 22	Test strip, disposal	26
Plasma calibration	43, 45	Time setting	4, 5
Repeated unexpected glucose results	25	Turning meter off	3
Result screen	23, 27	Turning meter on for reviewing results	3, 27
Results, reviewing past	27	Turning meter on for testing	3, 8
Set up	4	Unexpected test results	24, 25
Start-up test screen	3, 8	Unit of measure	4, 24
Storing your control solution	33		
Storing your meter	33		
Storing your test strips	33		
Symbols	46		
System components	1		
Technical specifications	45		
Temperature error message	38		
Temperature	7, 23, 28, 33, 38, 40, 45		
Testing procedure	7		

Reminders

Time of day

*Your target ranges
from your healthcare professional*

Before breakfast

Before lunch or dinner

1 hour after meals

2 hours after meals

Between 2 a.m. and 4 a.m.

Patent information

The system described herein is covered by one or more of the following U.S. patents: 5,708,247, 5,951,836, 6,241,862, and 6,284,125. Use of the monitoring device included herein is protected under one or more of the following U.S. patents: 6,413,410, 6,733,655. Purchase of this device does not act to grant a use license under these patents. Such a license is granted only when the device is used with OneTouch® Ultra® Test Strips. No test strip supplier other than LifeScan is authorized to grant such a license. The accuracy of results generated with LifeScan meters using test strips manufactured by anyone other than LifeScan has not been evaluated by LifeScan.

Call LifeScan Customer Service toll-free,
24 hours a day, 7 days a week/
Llame gratuitamente a Servicio de atención al
cliente de LifeScan,
24 horas al día, 7 días a la semana

English **1 800 227-8862**

Español **1 800 381-7226**

Or/O bien,

Visit us at/

Visitenos en:

English www.LifeScan.com

Español www.OneTouchEnEspanol.com



AW 06397301A

© 2006 LifeScan, Inc. Milpitas, CA 95035

Rev. date: 04/2006