

t:slim X2

Insulin Pump

WITH Basal-IQ TECHNOLOGY



User Guide



TANDEM
Diabetes Care

MG/DL

t:slim X2 Insulin Pump with Basal-IQ Technology User Guide

Software Version: Basal-IQ 6.4

Congratulations on the purchase of your new t:slim X2™ insulin pump with Basal-IQ™ technology.

This user guide is designed to assist you with the features and functions of the t:slim X2 insulin pump with Basal-IQ technology. It provides important warnings and cautions on proper operation as well as technical information to ensure your safety. It also provides step-by-step instructions on how to properly program, manage and care for your t:slim X2 insulin pump with Basal-IQ technology.

Changes in equipment, software, or procedures occur periodically; information describing these changes will be included in future editions of this user guide.

No part of this publication may be reproduced, stored in a retrieval system, nor transmitted in any form or by any means, electronic or mechanical, without the prior written permission of Tandem Diabetes Care.

Please contact Customer Technical Support to obtain a replacement copy of the user guide that is the correct version for your pump. For contact information in your region see the back cover of this user guide.

Tandem Diabetes Care, Inc.
11075 Roselle Street
San Diego, CA 92121 USA
tandemdiabetes.com

TABLE OF CONTENTS

Section 1: Before You Begin

Chapter 1 • Introduction

1.1	Conventions of this Guide	14
1.2	Explanation of Symbols	16
1.3	System Description	18
1.4	About this User Guide	18
1.5	Indications for Use	19
1.6	Compatible iCGMs	19
1.7	Important User Information	20
1.8	Important Pediatric User Information	20
1.9	Emergency Kit	21

Section 2: t:slim X2 Insulin Pump Features

Chapter 2 • Important Safety Information

2.1	t:slim X2 Insulin Pump Warnings	24
2.2	Magnetic Resonance Imaging Safety	26
2.3	Radiology and Medical Procedures and Your t:slim X2 Pump	27
2.4	t:slim X2 Insulin Pump Precautions	27
2.5	Potential Benefits From Using Your Pump	30
2.6	Possible Risks From Using Your Pump	31
2.7	Working with your Healthcare Provider	31
2.8	Verification of Proper Functionality	32

Chapter 3 • Getting to Know Your t:slim X2 Insulin Pump

3.1	What your t:slim X2 Pump Package Includes	34
-----	---	----

3.2	Pump Terminology	34
3.3	Explanation of t:slim X2 Insulin Pump Icons	37
3.4	Explanation of Pump Colors	39
3.5	Lock Screen	40
3.6	Home Screen	42
3.7	Current Status Screen	44
3.8	Bolus Screen	46
3.9	Options Screen	48
3.10	My Pump Screen	50
3.11	Device Settings Screen	52
3.12	Number Keypad Screen	54
3.13	Letter Keypad Screen	56

Chapter 4 • Getting Started

4.1	Charging the t:slim X2 Pump	60
4.2	Turning the Pump On	61
4.3	Using the Touchscreen	61
4.4	Turning on the t:slim X2 Pump Screen	62
4.5	Turning the Pump Screen Off	62
4.6	Turning the Pump Off	62
4.7	Unlocking the t:slim X2 Pump Screen	62
4.8	Edit Time	63
4.9	Edit Date	63
4.10	Basal Limit	63
4.11	Display Settings	64
4.12	Sound Volume	65
4.13	Turn Security PIN On or Off	65

Chapter 5 • Infusion Site Care and Loading Cartridge

5.1	Infusion Site Selection and Care	68
5.2	Cartridge Instructions for Use	69

5.3	Filling and Loading a t:slim X2 Cartridge	70
5.4	Filling Tubing	75
5.5	Filling Cannula	77
5.6	Setting Site Reminder	78

Chapter 6 • Personal Profiles

6.1	Personal Profiles Overview	80
6.2	Creating a New Profile	80
6.3	Programming a New Personal Profile	82
6.4	Editing or Reviewing an Existing Profile	84
6.5	Duplicating an Existing Profile	85
6.6	Activating an Existing Profile	85
6.7	Renaming an Existing Profile	85
6.8	Deleting an Existing Profile	86
6.9	Starting a Temporary Basal Rate	86
6.10	Stopping a Temp Rate	87

Chapter 7 • Manual Bolus

7.1	Manual Bolus Overview	90
7.2	Correction Bolus Calculation	90
7.3	Bolus Override	92
7.4	Food Bolus Using Units	92
7.5	Food Bolus Using Grams	93
7.6	Extended Bolus	93
7.7	Max Bolus	94
7.8	Quick Bolus	95
7.9	Canceling or Stopping a Bolus	97

Chapter 8 • Start, Stop, or Resume Insulin

8.1	Starting Insulin Delivery	100
8.2	Stopping Insulin Delivery	100

8.3	Resuming Insulin Delivery	100
Chapter 9 • t:slim X2 Insulin Pump Information and History		
9.1	t:slim X2 Pump Info	102
9.2	t:slim X2 Pump History	102
Chapter 10 • t:slim X2 Insulin Pump Reminders		
10.1	Low BG Reminder	104
10.2	High BG Reminder	104
10.3	After Bolus BG Reminder	105
10.4	Missed Meal Bolus Reminder	106
10.5	Site Reminder	106
Chapter 11 • User Settable Alerts and Alarms		
11.1	Low Insulin Alert	108
11.2	Auto-Off Alarm	108
11.3	Max Basal Alert	109
Chapter 12 • t:slim X2 Insulin Pump Alerts		
12.1	Low Insulin Alert	113
12.2	Low Power Alerts	114
12.3	Incomplete Bolus Alert	116
12.4	Incomplete Temp Rate Alert	117
12.5	Incomplete Load Sequence Alerts	118
12.6	Incomplete Setting Alert	121
12.7	Basal Rate Required Alert	122
12.8	Max Hourly Bolus Alert	123
12.9	Max Bolus Alerts	124
12.10	Max Basal Alert	126
12.11	Min Basal Alerts	127
12.12	Connection Error Alert	129

12.13	Pairing Code Timeout	130
12.14	Power Source Alert	131
12.15	Data Error Alert	132

Chapter 13 • t:slim X2 Insulin Pump Alarms

13.1	Resume Pump Alarm	135
13.2	Low Power Alarm	136
13.3	Empty Cartridge Alarm	137
13.4	Cartridge Error Alarm	138
13.5	Cartridge Removal Alarm	139
13.6	Temperature Alarm	140
13.7	Occlusion Alarm 1	141
13.8	Occlusion Alarm 2	142
13.9	Screen On/Quick Bolus Button Alarm	143
13.10	Altitude Alarm	144
13.11	Reset Alarm	145

Chapter 14 • t:slim X2 Insulin Pump Malfunction

14.1	Malfunction	148
------	-------------	-----

Chapter 15 • Taking Care of Your Pump

15.1	Overview	152
------	----------	-----

Chapter 16 • Lifestyle Issues and Travel

16.1	Overview	154
------	----------	-----

Section 3: CGM Features

Chapter 17 • Important CGM Safety Information

17.1	CGM Warnings	158
------	--------------	-----

17.2	CGM Precautions	159
17.3	Potential Benefits From Using the t:slim X2 System	160
17.4	Possible Risks From Using the t:slim X2 System	161
Chapter 18 • Getting to Know Your CGM System		
18.1	CGM Terminology	164
18.2	Explanation of CGM Pump Icons	166
18.3	CGM Lock Screen	168
18.4	CGM Home Screen	170
18.5	My CGM Screen	172
Chapter 19 • CGM Overview		
19.1	CGM System Overview	176
19.2	Receiver (t:slim X2 Insulin Pump) Overview	176
19.3	Transmitter Overview	176
19.4	Sensor Overview	177
Chapter 20 • CGM Settings		
20.1	About Bluetooth Technology	180
20.2	Disconnecting from the Dexcom Receiver	180
20.3	Entering Your Transmitter ID	180
20.4	Setting CGM Volume	181
20.5	CGM Info	183
Chapter 21 • Setting CGM Alerts		
21.1	Setting Your High Glucose Alert and Repeat Feature	186
21.2	Setting Your Low Glucose Alert and Repeat Feature	187
21.3	Rate Alerts	188
21.4	Setting Your Rise Alert	188
21.5	Setting Your Fall Alert	189
21.6	Setting Your Out of Range Alert	189

Chapter 22 • Start or Stop a CGM Sensor Session

22.1	Start the Sensor	192
22.2	Sensor Startup Period	194
22.3	Automatic Sensor Shut-Off	196
22.4	Ending a Sensor Session Before Automatic Shut-Off	196
22.5	Removing the Sensor and Transmitter	196

Chapter 23 • Calibrating Your CGM System

23.1	Calibration Overview	198
23.2	Startup Calibration	198
23.3	Calibration BG Value and Correction Bolus	200
23.4	24 Hour Calibration Update	200
23.5	Other Reasons You May Need to Calibrate	201

Chapter 24 • Viewing CGM Data on Your t:slim X2 Insulin Pump

24.1	Overview	204
24.2	CGM Trend Graphs	205
24.3	Rate of Change Arrows	206
24.4	CGM History	208
24.5	Missed Readings	208

Chapter 25 • CGM Alerts and Errors

25.1	Startup Calibration Alert	211
25.2	Second Startup Calibration Alert	212
25.3	12 Hour Calibration Alert	213
25.4	Incomplete Calibration	214
25.5	Calibration Timeout	215
25.6	Wait 15 Minute Calibration Error Alert	216
25.7	Calibration Required Alert	217
25.8	CGM High Alert	218
25.9	CGM Low Alert	219

25.10	CGM Fixed Low Alert	220
25.11	CGM Rise Alert	221
25.12	CGM Rapid Rise Alert	222
25.13	CGM Fall Alert	223
25.14	CGM Rapid Fall Alert	224
25.15	Unknown Sensor Reading	225
25.16	Out of Range Alert	226
25.17	Low Transmitter Battery Alert	227
25.18	Transmitter Error	228
25.19	Failed Sensor Error	229
25.20	CGM Unavailable	230
25.21	CGM System Error	231

Chapter 26 • CGM Troubleshooting

26.1	CGM Pairing Troubleshooting	234
26.2	Calibration Troubleshooting	234
26.3	Unknown Sensor Reading Troubleshooting	234
26.4	Out of Range/No Antenna Troubleshooting	235
26.5	Failed Sensor Troubleshooting	236
26.6	Sensor Inaccuracies	236

Section 4: Basal-IQ Technology Features

Chapter 27 • Basal-IQ Technology Important Safety Information

27.1	Basal-IQ Warnings	240
27.2	Basal-IQ Precautions	240

Chapter 28 • Getting to Know Basal-IQ Technology

28.1	Responsible Use of Basal-IQ Technology	242
28.2	Explanation of Basal-IQ Icons	242

28.3	Basal-IQ Lock Screen	244
28.4	Basal-IQ Home Screen	246
28.5	Basal-IQ Screen	248
Chapter 29 • Basal-IQ Technology Overview		
29.1	Basal-IQ Overview	252
29.2	How Basal-IQ Works	252
29.3	Turn Basal-IQ On and Off	255
Chapter 30 • Viewing Basal-IQ Technology Status on Your t:slim X2 Pump		
30.1	Overview	258
30.2	Basal-IQ Status Indicators	258
30.3	Basal-IQ History	259
Chapter 31 • Basal-IQ Technology Alerts		
31.1	Out of Range Alert	263
31.2	Suspend Alert	264
31.3	Resume Alerts	265
Chapter 32 • Basal-IQ Technology Clinical Study Overview		
32.1	Introduction	268
32.2	Clinical Study Overview	268
32.3	Demographics	269
32.4	Intervention Compliance	270
32.5	Primary Analysis	272
32.6	Secondary Analysis	274
32.7	Insulin Delivery Differences	276
32.8	Basal-IQ Technology Performance Accuracy	278

Section 5: Technical Specifications and Warranty

Chapter 33 • Technical Specifications

33.1	Overview	282
33.2	t:slim X2 Pump Specifications	283
33.3	t:slim X2 Pump Options and Settings	288
33.4	t:slim X2 Pump Performance Characteristics	290
33.5	Electromagnetic Compatibility	295
33.6	Wireless Co-existence and Data Security	295
33.7	Electromagnetic Emissions	296
33.8	Electromagnetic Immunity	297
33.9	Quality of Wireless Service	299
33.10	Wireless Technology	300
33.11	FCC Notice Concerning Interference	301
33.12	Warranty Information	301
33.13	Returned Goods Policy	305
33.14	t:slim X2 Insulin Pump Event Data (Black Box)	306
33.15	Product List	306

Index

308

This Page is Intentionally Left Blank

1 Before You Begin



CHAPTER 1

Introduction



1.1 Conventions of this Guide

The following are conventions used in this user guide (such as terms, icons, text formatting, and other conventions) along with their explanations.

Formatting Conventions

Convention	Explanation
Bolded Text	Text that is in bold and in a different font than the rest of the sentence or step indicates an on-screen icon or physical button name.
<i>Italic Text</i>	Text that is in italics indicates the name of a screen or menu on the pump display.
Touchscreen	The front glass screen of your pump, which displays all programming, operating, and alarm/alert information.
Tap	Quickly and lightly touch the screen with your finger.
Press	Use your finger to depress a physical button (the Screen On/Quick Bolus button is the only physical/hardware button on your pump).
Hold	Keep pressing a button or touching an icon or menu until its function is complete.
Menu	A list of options on your touchscreen that allow you to perform specific tasks.
Icon	An image on your touchscreen that indicates an option or item of information, or a symbol on the back of your pump or its packaging.
	Calls out an important note regarding the use or operation of the system.
	Calls out safety precautions which, if ignored, could result in minor or moderate injury.







Formatting Conventions (Continued)









Convention	Explanation
	Calls out critical safety information which, if ignored, could result in serious injury or death.
	Indicates how the pump responds to the previous instruction.

1.2 Explanation of Symbols







The following are symbols (and their descriptions), which you may find on your pump, pump supplies and/or their packaging. These symbols tell you about the proper and safe use of the pump. Some of these symbols may not be relevant in your region, and are listed for informational purposes only.







Explanation of t:slim X2 Insulin Pump Symbols

Symbol	Meaning
	Caution
	Follow instructions for use
R _x Only	For sale by or on the order of a physician only (U.S.)
	Catalogue number
	Batch code
IPX7	International Protection (IP) Code
	Manufacturer
	Date of manufacture

Symbol	Meaning
	Type BF Applied Part (patient isolation, not defibrillator protected)
	Consult instructions for use
	Non-ionizing Radiation
	Serial number
	Medical device
	Authorized Representative in the European Community
	Regulatory Compliance Mark
	CE marking of conformity

Explanation of t:slim X2 Insulin Pump Symbols (Continued)

Symbol	Meaning
	Direct Current (DC) voltage
	Separate collection for waste electrical and electronic equipment
	Electric Equipment Designed Primarily for Indoor Use
	IEC Class II Equipment
	Wall power USB adapter
	Cartridge removal tool
	USB cable

Symbol	Meaning
	Humidity limitation
	Temperature limit
	Keep dry
	Outlet adapter
	Pump case
	User guide

1.3 System Description

The t:slim X2™ insulin pump is made up of the t:slim X2 insulin pump, the t:slim X2 3mL (300 units) cartridge, and a compatible infusion set. In this user guide, the t:slim X2 insulin pump may be referred to as the “pump” or the “t:slim X2 pump.”

The combination of the t:slim X2 pump with Basal-IQ™ technology and a compatible continuous glucose monitor (CGM) may be referred to as the “System.”

The Dexcom G6 transmitter may be referred to as the “transmitter.” The Dexcom G6 sensor may be referred to as the “sensor.” Together, the Dexcom G6 transmitter and Dexcom G6 sensor may be referred to as the “CGM.”

The pump delivers insulin in two ways: basal insulin delivery (continuous) and bolus insulin delivery. The disposable cartridge is filled with up to 300 units of U-100 insulin and attached to the pump. The cartridge is replaced every 48–72 hours.

The t:slim X2 pump comes preloaded with Basal-IQ technology, or can be updated to include Basal-IQ technology. The addition of this feature enables the t:slim X2 System to automatically suspend and resume the delivery of insulin based on CGM sensor readings. The Basal-IQ technology utilizes the CGM sensor readings to calculate a predicted sensor glucose value 30 minutes into the future. For more information on how Basal-IQ technology is activated, see [Chapter 29 Basal-IQ Technology Overview](#).

The pump can be used for basal and bolus insulin delivery with or without a CGM. If a CGM is not used, sensor glucose readings will not be sent to the pump display and you will not be able to use Basal-IQ technology.

The sensor is a disposable device that is inserted under the skin to continuously monitor glucose levels for up to 10 days. The transmitter connects to the sensor pod and wirelessly sends readings to the pump, which acts as a receiver for the therapeutic CGM, every 5 minutes. The

pump shows sensor glucose readings, trend graph, direction and rate of change arrows.

The sensor measures glucose in the fluid under the skin—not in blood, and sensor readings are not identical to readings from a BG meter.

The t:connect™ mobile app enables you to connect a smartphone to the pump using Bluetooth wireless technology to display your pump information on the smartphone. The t:connect mobile app may not yet be available in your region.

1.4 About this User Guide

This user guide covers important information on how to operate your System. It provides step-by-step instructions to help you properly program, manage and care for the System. It also provides important warnings and cautions on proper operation and technical information to ensure your safety.

The user guide is organized into sections. Section 1 provides important

information you need to know before you start using the System. Section 2 covers instructions for using the t:slim X2 pump. Section 3 covers instructions for using CGM with your pump. Section 4 covers instructions for using Basal-IQ technology on your pump. Section 5 provides information on the technical specifications of your pump.

Pump screens used in this user guide to demonstrate how to use features are examples only. They should not be considered suggestions for your individual needs.

Product information, including electronic versions of the user guide, Guide to Successful Pumping, t:connect Getting Started Guide, t:connect user guides, and a CGM training tutorial are available at tandemdiabetes.com.

1.5 Indications for Use

The t:slim X2 insulin pump with interoperable technology (the Pump) is intended for the subcutaneous delivery of insulin, at set and variable rates, for the management of diabetes mellitus in

persons requiring insulin. The Pump is able to reliably and securely communicate with compatible, digitally connected devices, including automated insulin dosing software, to receive, execute, and confirm commands from these devices.

The Pump is intended for single patient, home use and requires a prescription.

The Pump is indicated for use with NovoLog (Novo Nordisk Insulin Aspart) or Humalog (Eli Lilly Insulin Lispro) U-100 insulin.

The Pump is indicated for use in individuals six years of age and greater.

Basal-IQ technology is intended for use with compatible integrated continuous glucose monitors (iCGM) and alternate controller enabled (ACE) pumps to automatically suspend delivery of insulin based on iCGM readings and predicted glucose values.

Basal-IQ technology is intended for the management of diabetes mellitus in persons six years of age and greater.

Basal-IQ technology is intended for single patient use and requires a prescription.

Basal-IQ technology is indicated for use with NovoLog (Novo Nordisk Insulin Aspart) or Humalog (Eli Lilly Insulin Lispro) U-100 insulin.

The bolus calculator is indicated for the management of diabetes by people with diabetes by calculating an insulin dose or carbohydrate intake based on user entered data.

1.6 Compatible iCGMs

Compatible iCGMs include the following:

- Dexcom G6 CGM

For information about Dexcom G6 CGM product specifications and performance characteristics, visit the manufacturer's website for applicable user guides.

The Dexcom G6 sensors and transmitters are sold and shipped separately by Dexcom.

NOTE

The Dexcom G6 CGM currently allows pairing with one medical device at a time (either the t:slim X2 pump or the Dexcom receiver), but you can still use the Dexcom G6 CGM app and your t:slim X2 pump simultaneously using the same transmitter ID.

NOTE

Product information for the Dexcom G6 CGM System includes important information on how to use the Dexcom G6 CGM information (including sensor glucose readings, trend graph, trend arrow, alarm/alerts) to make treatment decisions. Ensure that you have reviewed this information and discussed it with your healthcare provider, who can guide you in correctly using your Dexcom G6 CGM information when making treatment decisions.



1.7 Important User Information

Review all instructions in this user guide before using the System.

If you are not able to use the System according to the instructions in this user guide, you may be putting your health and safety at risk.

If you are new to using CGM, continue using your BG meter until you are familiar with CGM usage.

If you are currently using the pump without Dexcom G6 CGM, or if you are currently using Dexcom G6 CGM, it is still very important that you review all instructions in this user guide before using the combined System.

Pay special attention to Warnings and Precautions in this user guide. Warnings and Precautions are identified with a  or  symbol.

If you still have questions after reading this user guide, contact Customer Technical Support.

1.8 Important Pediatric User Information

The following recommendations are meant to help younger users and their caregivers program, manage and care for the System.

Younger children may inadvertently press or tap the pump, leading to unintentional delivery of insulin.

It is the responsibility of the healthcare provider and caregiver to determine if the user is appropriate for treatment with this device.

We recommend reviewing the Quick Bolus and Security PIN capabilities of the pump and determining how they best fit with your care plan. These features are detailed in [Chapters 7 Manual Bolus](#) and [4 Getting Started](#).

Inadvertent dislodgement of the infusion site may occur more frequently with children so consider securing the infusion site and tubing.

▲ WARNING

DO NOT allow small children (either pump users or non-users) to ingest small parts, such as the rubber USB port cover and cartridge components. Small parts could pose a choking hazard. If ingested or swallowed, these small component pieces may cause internal injury or infection.

▲ WARNING

The pump includes parts (such as the USB cable and infusion set tubing) that could pose a strangulation or asphyxiation hazard. Always use the appropriate length of infusion set tubing

and arrange cables and tubing to minimize the risk of strangulation. **ENSURE** that these parts are stored in a secure place when not in use.

▲ WARNING

For patients who do not self-manage their disease, the Security PIN function should **ALWAYS** be on when the pump is not being used by a caregiver. The Security PIN function is intended to prevent inadvertent screen taps or button presses that may lead to insulin delivery or changes in the pump settings. These changes can potentially lead to hypoglycemia (low BG) or hyperglycemia (high BG) events. See [Section 4.13 Turn Security PIN On or Off](#) for details on how to turn the Security PIN function on.

▲ WARNING

For patients whose insulin administration is managed by a caregiver, **ALWAYS** turn off the Quick Bolus feature to avoid inadvertent bolus delivery. If the Security PIN is turned on, the Quick Bolus feature is automatically disabled. Inadvertent screen taps, button presses, or tampering with the insulin pump could result in over delivery or under delivery of insulin. This can cause hypoglycemia (low BG) or hyperglycemia (high BG) events. See [Section](#)

[4.13 Turn Security PIN On or Off](#) for details on how to turn the Security PIN function off.

1.9 Emergency Kit

Make sure that you always have an insulin syringe and vial of insulin or a prefilled insulin pen with you as a backup for emergency situations. You should also always have an appropriate emergency kit with you. Talk with your healthcare provider regarding what items this kit should include.

Supplies to carry every day:

- Insulin pump cartridges (minimum of 2)
- Infusion site preparation products (antiseptic wipes, skin adhesive)
- Diabetes identification card or jewelry
- BG testing supplies: meter, strips, control solution, lancets, meter batteries
- Fast-acting carbohydrate to treat low BG
- Extra snack for longer coverage than fast-acting carbohydrate
- Glucagon emergency kit
- Rapid-acting insulin and syringes or a prefilled insulin pen
- Infusion sets (minimum of 2)

This Page is Intentionally Left Blank

2 t:slim X2 Insulin Pump Features

CHAPTER 2

Important Safety Information

The following includes important safety information related to your t:slim X2™ pump and its components. The information presented in this chapter does not represent all warnings and precautions related to the System. Pay attention to other warnings and precautions listed throughout this user guide as they relate to special circumstances, features, or users.

2.1 t:slim X2 Insulin Pump Warnings

t:slim X2 Insulin Pump

▲ WARNING

DO NOT start to use your pump before reading the user guide. Failure to follow the instructions in this user guide can result in over delivery or under delivery of insulin. This can cause hypoglycemia (low BG) or hyperglycemia (high BG) events. If you have questions or need further clarification on your pump use, ask your healthcare provider or call Customer Technical Support.

▲ WARNING

DO NOT start to use your pump before you have been appropriately trained on its use by a

certified trainer or through the training materials available online if you are updating your pump. Consult with your healthcare provider for your individual training needs for the pump. Failure to complete the necessary training on your pump could result in serious injury or death.

▲ WARNING

Only U-100 Humalog and NovoLog have been tested and found to be compatible for use with the pump. The use of lower or higher concentration insulin may cause over delivery or under delivery of insulin. This can cause hypoglycemia (low BG) or hyperglycemia (high BG) events.

▲ WARNING

DO NOT put any other drugs or medications in the pump. The pump has only been tested for Continuous Subcutaneous Insulin Infusion (CSII) with U-100 Humalog or U-100 NovoLog insulin. The pump may be damaged if other medicines are used and an infusion may result in damage to health.

▲ WARNING

The pump is not intended for anyone unable or unwilling to:

- » Test blood glucose (BG) levels as recommended by a healthcare provider
- » Demonstrate adequate carbohydrate-counting skills (preferred, not required)
- » Maintain sufficient diabetes self-care skills
- » See a healthcare provider(s) regularly

The user must also have adequate vision and/or hearing in order to recognize all functions of the pump, including alerts, alarms, and reminders.

▲ WARNING

DO NOT start to use your pump before consulting with your healthcare provider to determine which features are most appropriate for you. Only your healthcare provider can determine and help you adjust your basal rate(s), carb ratio(s), correction factor(s), target BG, and duration of insulin action. In addition, only your healthcare provider can determine your CGM settings and how you should use your sensor trend information to help you manage your diabetes. Incorrect settings can result in over delivery or under delivery of insulin. This can cause hypoglycemia (low BG) or hyperglycemia (high BG) events.

▲ WARNING

ALWAYS be prepared to inject insulin with an alternative method if delivery is interrupted for any reason. Your pump is designed to deliver insulin reliably, but because it uses only rapid-acting insulin, you will not have long-acting insulin in your body. Failure to have an alternative method of insulin delivery can lead to very high BG or Diabetic Ketoacidosis (DKA).

▲ WARNING

ONLY use cartridges and infusion sets with matching connectors and follow their instructions for use. Failure to do so may result in over delivery or under delivery of insulin and may cause hypoglycemia (low BG) or hyperglycemia (high BG) events.

▲ WARNING

DO NOT place your infusion set on any scars, lumps, moles, stretch marks or tattoos. Placing your infusion set in these areas can cause swelling, irritation or infection. This can affect insulin absorption and cause high or low BG.

▲ WARNING

ALWAYS carefully follow the instructions for use accompanying your infusion set for proper insertion and infusion site care, as failure to do

so could result in over delivery or under delivery of insulin or infection.

▲ WARNING

NEVER fill your tubing while your infusion set is connected to your body. Always ensure that the infusion set is disconnected from your body before filling the tubing. Failure to disconnect your infusion set from your body before filling the tubing can result in over delivery of insulin. This can cause hypoglycemia (low BG) events.

▲ WARNING

NEVER reuse cartridges or use cartridges other than those manufactured by Tandem Diabetes Care. Use of cartridges not manufactured by Tandem Diabetes Care or reuse of cartridges may result in over delivery or under delivery of insulin. This can cause hypoglycemia (low BG) or hyperglycemia (high BG) events.

▲ WARNING

ALWAYS twist the tubing connector between the cartridge tubing and the infusion set tubing an extra quarter of a turn to ensure a secure connection. A loose connection can cause insulin to leak, resulting in under delivery of insulin. If the connection comes loose, disconnect the infusion set from your body

before tightening. This can cause hyperglycemia (high BG).

▲ WARNING

DO NOT disconnect the tubing connector between the cartridge tubing and the infusion set tubing. If the connection comes loose, disconnect the infusion set from your body before tightening. Failure to disconnect before tightening can result in over delivery of insulin. This can cause hypoglycemia (low BG).

▲ WARNING

DO NOT remove or add insulin from a filled cartridge after loading onto the pump. This will result in an inaccurate display of the insulin level on the Home screen and you could run out of insulin before the pump detects an empty cartridge. This can cause very high BG, or Diabetic Ketoacidosis (DKA).

▲ WARNING

DO NOT deliver a bolus until you have reviewed the calculated bolus amount on the pump display. If you deliver an insulin amount that is too high or too low, this could cause hypoglycemia (low BG) or hyperglycemia (high BG) events. You can always adjust the insulin units up or down before you decide to deliver your bolus.

▲ WARNING

DO NOT allow small children (either pump users or non-users) to ingest small parts, such as the rubber USB port cover and cartridge components. Small parts could pose a choking hazard. If ingested or swallowed, these small component pieces may cause internal injury or infection.

▲ WARNING

The pump includes parts (such as the USB cable and infusion set tubing) that could pose a strangulation or asphyxiation hazard. **ALWAYS** use the appropriate length of infusion set tubing and arrange cables and tubing to minimize the risk of strangulation. **ENSURE** that these parts are stored in a secure place when not in use.

▲ WARNING

For patients who do not self-manage their disease, the Security PIN function should **ALWAYS** be on when the pump is not being used by a caregiver. The Security PIN function is intended to prevent inadvertent screen taps or button presses that may lead to insulin delivery or changes in the pump settings. These changes can potentially lead to hypoglycemic or hyperglycemic events.

▲ WARNING

For patients whose insulin administration is managed by a caregiver, **ALWAYS** turn off the Quick Bolus feature to avoid inadvertent bolus delivery. If the Security PIN is turned on, the Quick Bolus feature is automatically disabled. Inadvertent screen taps, button presses, or tampering with the insulin pump could result in over delivery or under delivery of insulin. This can cause hypoglycemia (low BG) or hyperglycemia (high BG) events.

▲ WARNING

DO NOT change your infusion set before bedtime or if you will not be able to test your BG 1–2 hours after the new infusion set is placed. It is important to confirm that the infusion set is inserted correctly and delivering insulin. It is also important to respond quickly to any problems with the insertion to ensure continued insulin delivery.

▲ WARNING

Use of accessories, cables, adapters, and chargers other than those specified or provided by the manufacturer of this equipment could result in increased electromagnetic emissions or decreased electromagnetic immunity of this equipment and result in improper operation.

▲ WARNING

Portable RF communications equipment (including peripherals such as antenna cables and external antennas) should be used no closer than 12 inches to any part of the t:slim X2 pump, including cables specified by the manufacturer. Otherwise, degradation of the performance of this equipment could result.

▲ WARNING

Use of this equipment adjacent to or stacked with other equipment should be avoided because it could result in improper operation. If such use is necessary, this equipment and the other equipment should be observed to verify that they are operating normally.

2.2 Magnetic Resonance Imaging Safety

▲ WARNING

The pump is magnetic resonance (MR) unsafe. You must take off your pump, transmitter, and sensor and leave them outside the procedure room.

2.3 Radiology and Medical Procedures and Your t:slim X2 Pump

▲ WARNING

ALWAYS notify the provider/technician about your diabetes and your pump. If you need to discontinue use of the pump for medical procedures, follow your healthcare provider's instructions to replace missed insulin when you reconnect to the pump. Check your BG before disconnecting from the pump and again when you reconnect and treat high BG levels as recommended by your healthcare provider.

▲ WARNING

DO NOT expose your pump, transmitter, or sensor to:

- » X-ray
- » Computed Tomography (CT) scan
- » Magnetic Resonance Imaging (MRI)
- » Positron Emission Tomography (PET) scan
- » Other exposure to radiation

▲ WARNING

There is no need to disconnect for electrocardiograms (EKGs) or colonoscopies. If

you have questions, contact Customer Technical Support.

▲ WARNING

DO NOT use the pump if you have a condition which, in the opinion of your healthcare provider, would put you at risk. Examples of individuals who should not use the pump include those with uncontrolled thyroid disease, renal failure (e.g. dialysis or eGFR <30), hemophilia, or another major bleeding disorder, or unstable cardiovascular disease.

▲ WARNING

DO NOT expose your pump, transmitter, or sensor to:

- » Pacemaker/Automatic Implantable Cardioverter Defibrillator (AICD) placement or reprogramming
- » Cardiac Catheterization
- » Nuclear Stress Test

You must take off your pump, transmitter, and sensor and leave them outside the procedure room if you are going to have any of the above medical procedures.

▲ WARNING

There are other procedures where you should proceed with caution:

- » **Laser Surgery** – Your System can usually be worn during the procedure. However, some lasers can create interference and cause the System to alarm.
- » **General Anesthesia** – Depending on the equipment being used, you may or may not need to remove your System. Be sure to ask your healthcare provider.

2.4 t:slim X2 Insulin Pump Precautions

▲ PRECAUTION

DO NOT open or attempt to repair your insulin pump. The pump is a sealed device that should be opened and repaired only by Tandem Diabetes Care. Modification could result in a safety hazard. If your pump seal is broken, the pump is no longer watertight and the warranty is voided.

▲ PRECAUTION

CHANGE your infusion set every 48 to 72 hours as recommended by your healthcare provider. Wash your hands with anti-bacterial soap before

handling the infusion set and thoroughly clean the insertion site on your body to avoid infection. Contact your healthcare provider if you have symptoms of infection at your insulin infusion site.

▲ PRECAUTION

ALWAYS remove all air bubbles from the pump before beginning insulin delivery. Ensure there are no air bubbles when drawing insulin into the filling syringe, hold the pump with the white fill port pointed up when filling the tubing, and ensure that there are no air bubbles in the tubing when filling. Air in the system takes space where insulin should be and can affect insulin delivery.

▲ PRECAUTION

CHECK your infusion site daily for proper placement and leaks. **REPLACE** your infusion set if you notice leaks around the site. Improperly placed sites or leaks around the infusion site can result in under delivery of insulin.

▲ PRECAUTION

CHECK your infusion set tubing daily for any leaks, air bubbles, or kinks. Air in the tubing, leaks in the tubing, or kinked tubing may restrict

or stop insulin delivery and result in under delivery of insulin.

▲ PRECAUTION

CHECK the tubing connection between your cartridge tubing and infusion set tubing daily to ensure it is tight and secure. Leaks around the tubing connection can result in under delivery of insulin.

▲ PRECAUTION

ALWAYS check that your cartridge has enough insulin to last through the night before going to bed. If you are sleeping, you could fail to hear the Empty Cartridge Alarm and miss part of your basal insulin delivery.

▲ PRECAUTION

CHECK your pump's personal settings regularly to ensure they are correct. Incorrect settings can result in over delivery or under delivery of insulin. Consult with your healthcare provider as needed.

▲ PRECAUTION

ALWAYS make sure that the correct time and date are set on your insulin pump. Not having the correct time and date setting may affect safe insulin delivery. When editing time, always check that the AM/PM setting is accurate, if

using the 12 hour clock. AM is to be used from midnight until 11:59 AM. PM is to be used from noon until 11:59 PM.

▲ PRECAUTION

CONFIRM that the screen display turns on, you can hear audible beeps, feel the pump vibrate, and see the green LED light blinking around the edge of the **Screen On/Quick Bolus** button when you connect a power source to the USB port. These features are used to notify you about alerts, alarms, and other conditions that require your attention. If these features are not working, discontinue use of the pump and contact Customer Technical Support.

▲ PRECAUTION

CHECK your pump regularly for potential alarm conditions that may display. It is important to be aware of conditions that may affect insulin delivery and require your attention so you can respond as soon as possible.

▲ PRECAUTION

DO NOT use the vibrate feature for alerts and alarms during sleep unless otherwise directed by your healthcare provider. Having the volume for alerts and alarms set to high will help ensure that you don't miss an alert or alarm.

▲ PRECAUTION

ALWAYS look at the screen to confirm correct programming of the bolus amount when you first use the Quick Bolus feature. Looking at the screen will ensure that you are correctly using the beep/vibration commands to program the intended bolus amount.

▲ PRECAUTION

DO NOT use your pump if you think it might be damaged due to dropping it or hitting it against a hard surface. Check that the pump is working properly by plugging a power source into the USB port and confirming that the display turns on, you hear audible beeps, feel the pump vibrate, and see the green LED light blinking around the edge of the **Screen On/Quick Bolus** button. If you are unsure about potential damage, discontinue use of the pump and contact Customer Technical Support.

▲ PRECAUTION

AVOID exposure of your pump to temperatures below 41°F (5°C) or above 99°F (37°C). Insulin can freeze at low temperatures or degrade at high temperatures. Insulin that has been exposed to conditions outside of the manufacturer's recommended ranges can affect the safety and performance of the pump.

▲ PRECAUTION

AVOID submerging your pump in fluid beyond a depth of 3 feet (0.91 m) or for more than 30 minutes (IPX7 rating). If your pump has been exposed to fluid beyond these limits, check for any signs of fluid entry. If there are signs of fluid entry, discontinue use of the pump and contact Customer Technical Support.

▲ PRECAUTION

AVOID areas where there may be flammable anesthetics or explosive gases. The pump is not suitable for use in these areas and there is a risk of explosion. Remove your pump if you need to enter these areas.

▲ PRECAUTION

MAKE SURE to not move further than the length of the USB cable when you are connected to the pump and to a charging source. Moving further than the length of the USB cable may cause the cannula to be pulled out of the infusion site. For this reason it is recommended not to charge the pump while sleeping.

▲ PRECAUTION

DISCONNECT your infusion set from your body while on high-speed/high gravity amusement park thrill rides. Rapid changes in altitude or

gravity can affect insulin delivery and cause injury.

▲ PRECAUTION

DISCONNECT your infusion set from your body before flying in an aircraft without cabin pressurization or in planes used for aerobatics or combat simulation (pressurized or not). Rapid changes in altitude or gravity can affect insulin delivery and cause injury.

▲ PRECAUTION

CONSULT your healthcare provider about lifestyle changes such as weight gain or loss, and starting or stopping exercise. Your insulin needs may change in response to lifestyle changes. Your basal rate(s) and other settings may need adjustment.

▲ PRECAUTION

CHECK your BG using a BG meter following a gradual elevation change of up to each 1,000 feet (305 meters), such as when snow skiing or driving on a mountain road. Delivery accuracy can vary up to 15% until 3 units of total insulin have been delivered or elevation has changed by more than 1,000 feet (305 meters). Changes in delivery accuracy can affect insulin delivery and cause injury.

▲ PRECAUTION

ALWAYS check with your healthcare provider for specific guidelines if you want or need to disconnect from the pump for any reason. Depending on the length of time and reason you are disconnecting, you may need to replace missed basal and/or bolus insulin. Check your BG before disconnecting from the pump and again when you reconnect, and treat high BG levels as recommended by your healthcare provider.

▲ PRECAUTION

ENSURE that your personal insulin delivery settings are programmed into the pump before use if you receive a warranty replacement. Failure to enter your insulin delivery settings could result in over delivery or under delivery of insulin. This can cause hypoglycemia (low BG) or hyperglycemia (high BG) events. Consult your healthcare provider as needed.

▲ PRECAUTION

ALWAYS dispose of used components such as cartridges, syringes, needles, infusion sets, and CGM sensors following the instructions from your healthcare provider. Wash your hands thoroughly after handling used components.

2.5 Potential Benefits From Using Your Pump

- The pump provides an automated way to deliver basal and bolus insulin. Delivery can be fine-tuned based on up to 6 customizable Personal Profiles, each with up to 16 time-based settings for basal rate, carb ratio, correction factor, and target BG. In addition, the temp rate feature allows you to program a temporary basal rate change for up to 72 hours.
- The pump gives you the option of delivering a bolus all at once, or delivering a percentage over an extended period of time without navigating to different menus. You can also program a bolus more discreetly using the Quick Bolus feature, which can be used without looking at the pump, and can be programmed in increments of either units of insulin or grams of carbohydrate.
- From the bolus screen, the “calculator within a calculator” feature allows you to enter multiple carbohydrate values and add them together. The insulin pump’s bolus calculator will recommend a bolus based on the entire amount of carbohydrates entered, which can help eliminate guesswork.
- The insulin pump keeps track of the amount of active insulin from food and correction boluses (IOB). When programming additional food or correction boluses, the pump will subtract the amount of IOB from the recommended bolus if your BG is below the target set in your active Personal Profile. This can help prevent insulin stacking, which can lead to hypoglycemia (low BG).
- You can program a number of reminders that will prompt you to retest your BG after a low or high BG is entered, as well as a “Missed Meal Bolus Reminder” which will alert you if a bolus isn’t entered during a specified period of time. If activated, these can help reduce the likelihood that you will forget to check your BG or bolus for meals.
- You have the ability to view a variety of data right on your screen,

including the time and amount of your last bolus, your total insulin delivery by day, as well as broken into basal, food bolus, and correction bolus.

2.6 Possible Risks From Using Your Pump

As with any medical device, there are risks associated with using your pump. Many of the risks are common to insulin therapy in general, but there are additional risks associated with continuous insulin infusion and continuous glucose monitoring. Reading your user guide and following the Instructions for Use are critical for the safe operation of your System. Consult your healthcare provider about how these risks may impact you.

Inserting and wearing an infusion set might cause infection, bleeding, pain or skin irritations (redness, swelling, bruising, itching, scarring or skin discoloration).

There is a remote chance that an infusion set cannula fragment could remain under your skin if the cannula

breaks while you are wearing it. If you think a cannula has broken under your skin, contact your healthcare provider and call Customer Technical Support.

Other risks associated with infusion sets include occlusions and air bubbles in the tubing, which can affect insulin delivery. If your BG does not decrease after initiating a bolus, or you have other unexplained high BG, it is recommended that you check your infusion set for an occlusion or air bubbles, and verify that the cannula has not dislodged. If the condition persists, call Customer Technical Support or seek medical attention as required.

Risks that could result from pump failure include the following:

- possible hypoglycemia (low BG) from over-delivery of insulin due to a hardware defect.
- hyperglycemia (high BG) and ketosis possibly leading to Diabetic Ketoacidosis (DKA) due to pump failure resulting in cessation of insulin delivery due to either a hardware defect or software anomaly.

2.7 Working with your Healthcare Provider

Any clinical language presented in this user guide is based on the assumption that you have been educated by your healthcare provider on certain terms and how they apply to you in your diabetes management. Your healthcare provider can help you establish diabetes management guidelines that best fit your lifestyle and needs.

Consult your healthcare provider before using the pump to determine which features are most appropriate for you. Only your healthcare provider can determine and help you adjust your basal rate(s), insulin-to-carbohydrate ratio(s), correction factor(s), BG target, and duration of insulin action. In addition, only your healthcare provider can determine your CGM settings and how you should use your sensor trend information to help you manage your diabetes.

2.8 Verification of Proper Functionality

A power supply (AC adapter with micro-USB connector) is provided with your pump. Before using your pump, ensure that the following occur when you connect a power supply into the USB port of your pump:

- You hear an audible alert
- You see the green light illuminate from the edge around the **Screen On/Quick Bolus** button
- You feel a vibratory alert
- You see a charge symbol (lightning bolt) on the battery level indicator

In addition, before using your pump, ensure the following:

- Press the **Screen On/Quick Bolus** button to turn the screen on so that you can see the display
- When the display screen is on, the touchscreen responds to your finger tap

▲ PRECAUTION

CONFIRM that the screen display turns on, you can hear audible beeps, feel the pump vibrate, and see the green LED light blinking around the edge of the **Screen On/Quick Bolus** button when you connect a power source to the USB port. These features are used to notify you about alerts, alarms, and other conditions that require your attention. If these features are not working, discontinue use of your pump and contact Customer Technical Support.

2 t:slim X2 Insulin Pump Features

CHAPTER 3

Getting to Know Your t:slim X2 Insulin Pump

3.1 What your t:slim X2 Pump Package Includes

Your pump package should include the following items:

1. t:slim X2™ insulin pump
2. pump case
3. t:slim X2 Insulin Pump with Basal-IQ™ Technology User Guide
4. USB cable
5. wall power USB adapter
6. cartridge removal tool

If any of these items are missing, contact Customer Technical Support.

If you use a CGM, the Dexcom G6 sensors and transmitters are sold and shipped separately by Dexcom.

Your pump is shipped with a clear screen protector. Do not remove the screen protector.

Your pump comes with a protective cover in the place where the cartridge is normally inserted. This cover must be removed and replaced with a cartridge prior to initiating insulin delivery.

The t:slim X2 3mL cartridge with t:lock™ connector consists of the reservoir chamber and a micro-delivery chamber for the delivery of very small amounts of insulin. A variety of compatible infusion sets with the t:lock connector are available from Tandem Diabetes Care, Inc. The t:lock connector allows a secure connection between the cartridge and the infusion set. Use only t:slim X2 cartridges and compatible infusion sets with t:lock connectors manufactured for Tandem Diabetes Care, Inc.

Your pump also includes consumable components that may require replacement during the life of your pump, including:

- pump case(s)/clip(s)
- screen protector
- USB rubber door
- USB cable

Supply Reordering

To order cartridges, infusion sets, supplies, accessories, screen protectors, please contact Customer Technical Support or your usual supplier of diabetes products.

3.2 Pump Terminology

Basal

Basal is a slow continuous delivery of insulin, which keeps glucose levels stable between meals and during sleep. It is measured in units per hour (units/hr).

BG

BG is the abbreviation for blood glucose, which is the level of glucose in the blood, measured in mg/dL.

BG Target

BG target is a specific BG or sensor goal, an exact number, not a range. When a BG or sensor glucose value is entered in the pump, the calculated insulin bolus will be adjusted up or down as needed to attain this target.

Bolus

A bolus is a quick dose of insulin that is usually delivered to cover food eaten or correct high glucose. With the pump it can be delivered as a Standard, a Correction, an Extended, or a Quick Bolus.

Cannula

The cannula is the part of the infusion set that is inserted under the skin through which insulin is delivered.

Carb

Carb or Carbohydrate refers to sugars and starches that the body breaks down into glucose and uses as an energy source, measured in grams.

Carb Ratio

The carb ratio is the number of grams of carbohydrate that 1 unit of insulin will cover. Also known as insulin-to-carbohydrate ratio.

Correction Bolus

A correction bolus is given to correct high glucose.

Correction Factor

A correction factor is the amount of BG that is lowered by 1 unit of insulin. Also

known as the Insulin Sensitivity Factor (ISF).

Extended Bolus

An extended bolus is a bolus that is delivered over a period of time. It is commonly used to cover food that takes longer to digest. When administering an extended bolus with your pump, enter the DELIVER NOW portion to dose a percentage of insulin immediately and the remaining percentage over a period time.

Grams

Grams are the measurement for a carbohydrate.

Insulin Duration

Insulin duration is the amount of time that insulin is active and available in the body after a bolus has been delivered. This also relates to the calculation for Insulin on Board (IOB).

Insulin On Board (IOB)

IOB is the insulin that is still active (has the ability to continue to lower the glucose) in the body after a bolus has been delivered.

Load

Load refers to the process of removing, filling, and replacing a new cartridge and infusion set.

Personal Profile

A personal profile is a personalized group of settings that defines the delivery of basal and bolus insulin within specific time segments throughout a 24 hour period.

Quick Bolus

Quick bolus (using the **Screen On/Quick Bolus** button) is a way to deliver a bolus by following beep/vibration commands without navigating through or viewing the pump screen.

Temp Rate

Temp rate is an abbreviation for a temporary basal rate. It is used to increase or decrease the current basal rate for a short period of time to accommodate special situations. 100% is the same basal rate as programmed. 120% means 20% more and 80% means 20% less than the programmed basal rate.

Units

Units are the measurement for insulin.









USB Cable

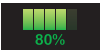







USB is the abbreviation for Universal Serial Bus. The USB cable connects into the pump's micro USB port.

3.3 Explanation of t:slim X2 Insulin Pump Icons



The following icons may appear on your pump screen:



Pump Icon Definitions

Symbol	Meaning
	The amount of charge left in the pump battery.
	A system reminder, alert, error, or alarm is active.
	All insulin deliveries are stopped.
	Basal insulin is programmed and being delivered.
	<i>Bluetooth</i> [®] wireless technology
	Accept. Tap to continue to the next screen or to answer yes to a message on the pump screen.
	Save. Tap to save settings on the screen.
	New. Tap to add a new item.
	Delete. Tap to delete characters or digits on a keypad.





Symbol	Meaning
	Amount of insulin remaining in the cartridge.
	A temporary basal rate is active.
	A basal rate of 0 u/hr is active.
	A temporary basal rate of 0 u/hr is active.
	A bolus is being delivered.
	Cancel. Tap to cancel the current operation.
	Decline. Tap to exit the screen or answer no to a message on the pump screen.
	Back. Tap to navigate to the previous screen.
	Total. Tap to total values on a keypad.

Pump Icon Definitions (Continued)

Symbol	Meaning
	Space. Tap to enter a space on the character keypad.
	The associated setting is turned on.
	Security PIN has been enabled. See Section 4.13 Turn Security PIN On or Off .

Symbol	Meaning
	OK. Tap to confirm the current instruction or setting on the screen.
	The associated setting is turned off.

3.4 Explanation of Pump Colors

	<p>Red LED 1 red blink every 30 seconds indicates a malfunction or alarm condition.</p>
	<p>Yellow LED 1 yellow blink every 30 seconds indicates an alert or reminder condition.</p>
	<p>Green LED</p> <ul style="list-style-type: none"> • 1 green blink every 30 seconds indicates the pump is functioning normally. • 3 green blinks every 30 seconds indicate the pump is charging.
	<p>Orange Highlight When editing settings, changes are highlighted in orange for review before saving.</p>

3.5 Lock Screen

The *Lock* screen appears anytime you turn on the screen. You must tap 1–2–3 in sequential order to unlock the pump.

1. **Time and Date Display:** Displays the current time and date.
2. **Alert Icon:** Indicates a reminder, alert or alarm is active behind the *Lock* screen.
3. **Battery Level:** Displays the level of battery power remaining. When connected for charging, the charging icon (lightning bolt) will display.
4. **1–2–3:** Unlocks pump screen.
5. **Insulin On Board (IOB):** Amount and time remaining of any active insulin on board.
6. **Active Bolus Icon:** Indicates a bolus is active.
7. **Status:** Displays current system settings and insulin delivery status.
8. **Insulin Level:** Displays the current amount of insulin in the cartridge.
9. **Tandem Logo:** Returns to the *Home* screen.



3.6 Home Screen

1. **Battery Level:** Displays the level of battery power remaining. When connected for charging, the charging icon (lightning bolt) will display.
2. **USB Port:** Port to charge your pump battery. Close the cover when not in use.
3. **Bolus:** Program and deliver a bolus.
4. **Options:** Stop/Resume insulin delivery, manage pump and CGM settings, program a temp rate, load cartridge, and view history.
5. **Insulin On Board (IOB):** Amount and time remaining of any active insulin on board.
6. **Time and Date Display:** Displays the current time and date.
7. **Status:** Displays current system settings and insulin delivery status.
8. **Insulin Level:** Displays the current amount of insulin in the cartridge.
9. **Tandem Logo:** Returns to the *Home* screen.
10. **Cartridge Tubing:** Tubing that is attached to the cartridge.
11. **Tubing Connector:** Connects the cartridge tubing to the infusion set tubing.
12. **Screen On/Quick Bolus button:** Turns the pump screen on/off or programs a Quick Bolus (if activated).
13. **LED Indicator:** Illuminates when connected to a power supply and indicates proper functionality.

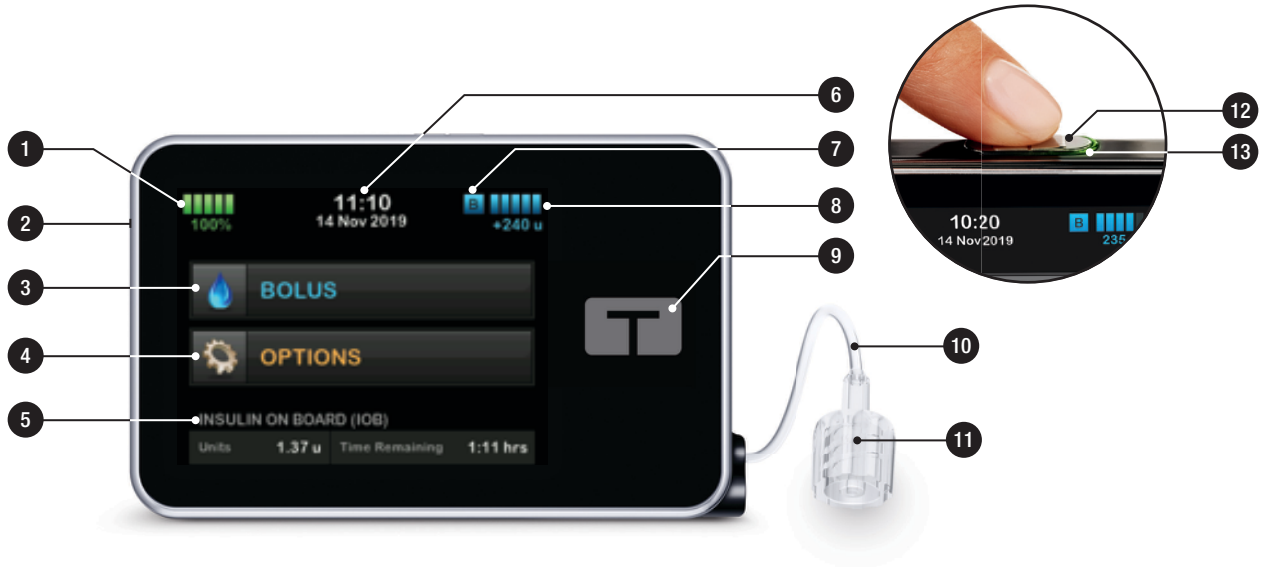



3.7 Current Status Screen

The *Current Status* screen can be accessed from the *Lock screen* and the *Home* screen. It is for display only; no changes can be made from this screen.

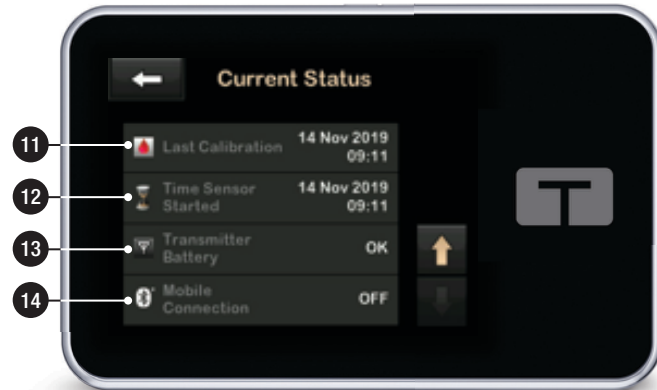
1. : Returns to the *Home* screen.
2. **Profile**: Displays current active Personal Profile.
3. **Basal Rate**: Displays current basal rate being delivered in units/hr. If a Temp Rate is active, this row will change to display current Temp Rate being delivered in units/hr.)
4. **Last Bolus**: Displays the amount, date and time of last bolus.
5. **Basal-IQ Status**: Displays the Basal-IQ technology status.
6. **Up/Down Arrow**: Indicates there is more information.
7. **Correction Factor**: Displays current correction factor used to calculate a bolus.
8. **Carb Ratio**: Displays current carb ratio used to calculate a bolus.
9. **Target BG**: Displays current BG target used to calculate a bolus.
10. **Insulin Duration**: Displays current insulin duration setting used to calculate insulin on board.
11. **Last Calibration**: Displays date and time of last calibration.
12. **Time Sensor Started**: Displays date and time of last time sensor started.
13. **Transmitter Battery**: Displays transmitter battery status.
14. **Mobile Connection**: Displays whether the mobile connection is turned on or off, whether a smartphone is paired with the pump, and if so whether the smartphone is actively connected to the pump.



3.8 Bolus Screen

1. : Returns to the *Home* screen.
2. **Carbs:** Enter grams of carbohydrate. See [Section 7.8 Quick Bolus](#) for details on how to set the Increment Type.
3. **Units:** Displays total units calculated. Tap to enter a bolus request or change (override) a calculated bolus.
4. **View Calculation:** Displays how the insulin dose was calculated using the current settings.
5. **Glucose:** Enter BG or sensor glucose level.
6. : Moves to next step.
7. **Insulin:** Enter units of insulin. See [Section 7.8 Quick Bolus](#) for details on how to set the Increment Type.

Using Grams



Using Units



3.9 Options Screen

1. : Returns to the *Home* screen.
2. **Stop Insulin:** Stops insulin delivery. If insulin delivery is stopped, RESUME INSULIN will be displayed.
3. **Load:** Change Cartridge, Fill Tubing, Fill Cannula, and Site Reminder.
4. **Temp Rate:** Programs a temporary basal rate.
5. **My Pump:** Personal Profiles, Basal-IQ, Alerts & Reminders, and Pump Info.
6. **Up/Down Arrow:** Indicates there is more information.
7. **My CGM:** Start/Stop Sensor, Calibrate CGM, CGM Alerts, Transmitter ID, and CGM Info.
8. **Device Settings:** Display settings, Bluetooth settings, Time and Date, Sound Volume, and Security PIN.
9. **History:** Displays historical log of pump and CGM events.



3.10 My Pump Screen

1. : Returns to the *Home* screen.
2. **Personal Profiles:** A group of settings that define basal and bolus delivery.
3. **Basal-IQ:** Turn on/off Basal-IQ Technology, and Basal-IQ Alerts.
4. **Alerts & Reminders:** Customize Pump Alerts and Reminders and Alerts.
5. **Pump Info:** Displays pump serial number, local customer support contact information website, and other technical information.





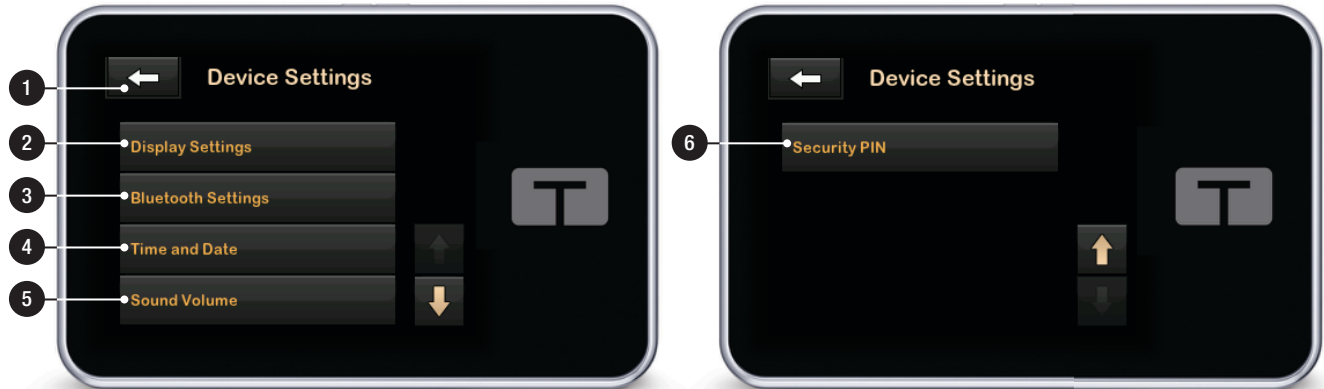

3.11 Device Settings Screen

1. : Returns to the *Options* screen.
2. **Display Settings:** Customize the Screen Timeout and Language settings.
3. **Bluetooth Settings:** Turn on/off mobile connection. The mobile connection may not yet be available in your region.
4. **Time and Date:** Edit the time and date that will be displayed on the pump.
5. **Sound Volume:** Customize the sound volume for pump alarms, pump alerts, reminders, keypad, bolus, quick bolus, fill tubing, and CGM alerts.
6. **Security PIN:** Turn on/off the Security PIN.





3.12 Number Keypad Screen

1. Value Entered.
2. : Returns to previous screen.
3. Keypad Numbers.
4. : Allows numbers to be added on gram screen. If in units, this displays as a decimal point.
5. : Completes task and saves information entered.
6. Units/Grams: Value of what is entered.
7. : Deletes last number entered.



3.13 Letter Keypad Screen

1. Name of Profile.
2. : Returns to previous screen.
3. **Space**: Enters a space.
4. **123**: Changes keypad mode from letters (ABC) to numbers (123).
5. : Saves entered information.
6. **Letters**: Tap once for first letter displayed, 2 quick taps for middle letter, and 3 quick taps for third letter.
7. : Deletes last letter or number entered.

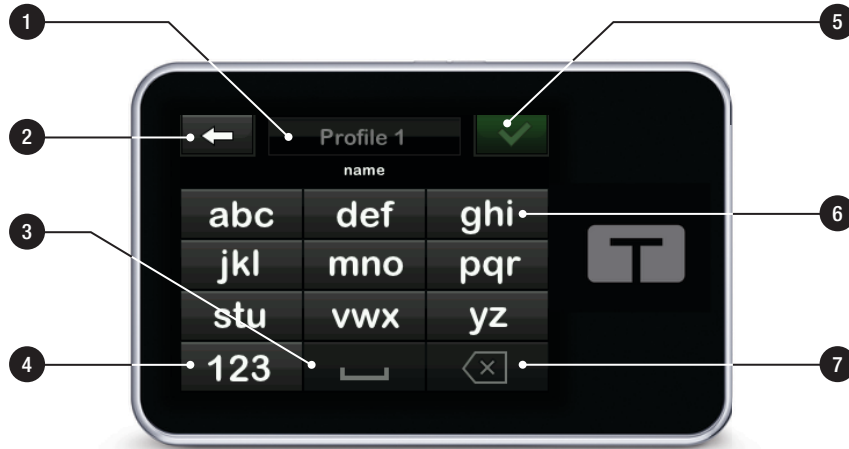

This Page is Intentionally Left Blank

2 t:slim X2 Insulin Pump Features

CHAPTER 4

Getting Started

4.1 Charging the t:slim X2 Pump

The pump is powered by an internal lithium polymer rechargeable battery. A full charge will typically last between 4 and 7 days, depending on your use of CGM and the t:connect mobile app features. If you utilize both CGM and the t:connect mobile app, your battery life will last up to 4 days. Please be aware that the battery life on a single charge can vary considerably depending on individual usage, including insulin delivered, display-on time, and frequency of reminders, alerts and alarms.

Accessories for charging from wall and automobile outlets, as well as from a computer USB port, are included with the pump. Use only the accessories provided to charge your pump. If you lose any of the accessories, or need a replacement, contact Customer Technical Support.

The battery level indicator is displayed in the upper left portion of the *Home* screen. The charge amount will increase or decrease by 5% at a time (for example, you will see 100%, 95%,

90%, 85%). When the charge amount is less than 5%, it will begin decreasing 1% at a time (for example, you will see 4%, 3%, 2%, 1%).

When you first receive your pump, you will need to connect it to a charging source before it can be used. Charge the pump until the battery level indicator on the upper left portion of the *Home* screen reads 100% (initial charge can take up to 2.5 hours).

The pump continues to operate normally while charging. You do not need to disconnect from the pump while charging.

▲ PRECAUTION

MAKE SURE to not move further than the length of the USB cable when you are connected to the pump and to a charging source. Moving further than the length of the USB cable may cause the cannula to be pulled out of the infusion site. For this reason it is recommended not to charge the pump while sleeping.

If you choose to disconnect from the pump while charging, check with your healthcare provider for specific guidelines. Depending on the length of time you are disconnected, you may need to

replace missed basal and/or bolus insulin. Check your BG before disconnecting from the pump and again when you reconnect.

To charge the pump from an AC Power Outlet:

1. Plug the included USB cable into the AC power adapter.
2. Plug the AC power adapter into a grounded AC power outlet.
3. Plug the other end of the cable into the micro USB port on the pump.

To charge the pump using an optional car power USB adapter:

1. Plug the USB cable into the car power USB adapter.
2. Plug the car power USB adapter into a grounded auxiliary power outlet.
3. Plug the other end of the cable into the micro USB port on the pump.

▲ WARNING

When using an optional car power USB adapter, the charger must be connected to an isolated, battery powered 12 Volt system, such as an automobile. Connecting the DC vehicle adapter charger to 12 Volt DC that is generated by a power supply connected to alternating current (AC) mains is prohibited.

To charge the pump using a USB port on a computer:

Ensure that the computer complies with the IEC 60950-1 (or equivalent) safety standard.

1. Plug the included USB cable into your computer.
2. Plug the other end of the cable into the micro USB port on the pump.

■ NOTE

Before using a computer to charge the pump, it is recommended that a driver be installed on the computer by downloading the t:connect uploader software from our website at tandemdiabetes.com. This will also allow communication between the pump, the computer, and the t:connect web application.

Depending on your computer, charging time will vary. The pump will display a CONNECTION ERROR ALERT message if it is not charging properly.

When you charge the pump, you will notice the following:

- The screen illuminates
- An audible alert
- The LED (edge around the **Screen On/Quick Bolus** button) blinks green
- A vibrating alert
- A charge symbol (lightning bolt) on the battery level indicator appears

▲ PRECAUTION

CONFIRM that the screen display turns on, you can hear audible beeps, feel the pump vibrate, and see the green LED light blinking around the edge of the **Screen On/Quick Bolus** button when you connect a power source to the USB port. These features are used to notify you about alerts, alarms, and other conditions that require your attention. If these features are not working, discontinue use of the t:slim X2™ pump and contact Customer Technical Support.

Charging Tips

Tandem Diabetes Care recommends that you periodically check the battery level indicator, charge the pump for a short period of time every day (10 to 15 minutes), and avoid frequent full discharges.

■ NOTE

If the battery is fully discharged, the screen may not power on immediately when connected to a charging source. The LED around the **Screen On/Quick Bolus** button will blink green until there is enough charge to power on the touchscreen.

4.2 Turning the Pump On

Plug in your pump to a charging source. The pump will make an audible noise when it has turned on and is ready for use.

4.3 Using the Touchscreen

To turn on your pump screen, first press the **Screen On/Quick Bolus** button, then use the pad of your finger to quickly and lightly tap on the screen.

Do not use your finger nail or other object to interact with the screen. It will not activate the screen or its functions.

Your pump is designed to give you quick and easy access to the functions that you will use in your day-to-day diabetes management whether basic or advanced.

The pump has several safety features to prevent unintentional interaction with the touchscreen. The screen must be unlocked by tapping 1–2–3 in sequence. On all screens, if three non-active areas of the touchscreen are tapped before an active area is tapped, the screen will turn off to prevent accidental screen interactions. There is also a Security PIN feature that can be set up to prevent unintentional access (see [Section 11.5 Turn Security PIN On or Off](#)).

NOTE

When using the pump, tap the **Tandem logo** to return to the *Home* screen or tap  to return to the previous screen.

4.4 Turning on the t:slim X2 Pump Screen

To turn on your pump screen, press the **Screen On/Quick Bolus** button, located on the top of the pump, once.

- ✓ The *Lock* screen will be displayed.

4.5 Turning the Pump Screen Off

To turn the pump screen off, press and release the **Screen On/Quick Bolus** button. This turns off the screen, but not the pump.

NOTE

Turn off the pump screen by pressing the **Screen On/Quick Bolus** button before placing the pump back in its case or any pocket/clothing. Always position the pump screen away from the skin when worn under clothing.

The pump continues to function normally when the screen is not on.

4.6 Turning the Pump Off

To turn the pump off completely, plug the pump into a power source and hold the **Screen On/Quick Bolus** button down for 30 seconds.

4.7 Unlocking the t:slim X2 Pump Screen

The *Lock* screen appears anytime you turn on the screen, and after a bolus or temp rate is requested. To unlock the screen:

1. Press **Screen On/Quick Bolus** button.
 2. Tap 1.
 3. Tap 2.
 4. Tap 3.
- ✓ The pump screen is now unlocked. The last screen that was viewed will be displayed.

You must tap 1–2–3 in sequential order to unlock the pump. If you do not tap

1–2–3 in sequential order, the pump will force you to restart the unlock sequence from the beginning.

If the Security PIN feature is enabled, you will need to enter your PIN after unlocking the screen.



4.8 Edit Time

After powering up your pump for the first time, set the current time and date. Refer back to this section if you need to edit the time for either traveling in a different time zone or adjusting for Daylight Savings Time.

▲ PRECAUTION

ALWAYS make sure that the correct time and date are set on your pump. Not having the correct time and date setting may affect safe insulin delivery. When editing time, always check that the AM/PM setting is accurate, if using the 12 hour clock. AM is to be used from midnight until 11:59 AM. PM is to be used from noon until 11:59 PM.



1. From the *Home* screen, tap **OPTIONS**.
2. Tap the **Down Arrow**.

3. Tap **Device Settings**.
4. Tap **Time and Date**.
5. Tap **Edit Time**.
6. Tap **Time**.
7. Using the on-screen keypad, enter the hour and minutes. Verify and tap .
8. Tap **Time of Day** to set AM or PM, or tap **24-hour Time** to toggle that setting on.
9. Verify the correct time is set and tap .

Any edits to Time or Date will not be saved until you tap .

4.9 Edit Date

1. From the *Time and Date* screen tap **Edit Date**.
2. Tap **Day**.

3. Using the on-screen keypad enter the current day. Verify and tap .
4. Tap **Month**.
5. Find and tap the current month displayed on the right. Use **Up/Down Arrow** to view months not displayed.
6. Tap **Year**.
7. Using the on-screen keypad enter the current year. Verify and tap .
8. Verify the correct date is set and tap .

Tap the **Tandem logo** to return to the *Home* screen.

4.10 Basal Limit

The Basal Limit setting allows you to set a limit to the basal rate that is set in the Personal Profiles, as well as the amount of insulin that will be delivered when using a Temp Rate.

You are unable to set any basal rates or temp basal rates that exceed the Basal Limit. You can set Basal Limit from 0.2 to 15 units per hour. Work with your healthcare provider to set the proper Basal Limit.

NOTE



If you are setting your Basal Limit after you have set any of your Personal Profiles, you cannot set your Basal Limit lower than any of your existing basal rates.

The default Basal Limit is 3 units per hour. If you are updating your pump from a version that did not previously have the Basal Limit setting, the Basal Limit will be set to a value two times the highest basal rate setting in your pump.

1. From the *Home* screen, tap **OPTIONS**.
2. Tap **My Pump**.
3. Tap **Personal Profiles**.
4. Tap **Pump Settings**.

5. Tap **Basal Limit**.



6. Using the on-screen keypad, enter a Basal Limit amount that is between 0.2 – 15 u/hr.
 7. Tap .
 8. Review the new Basal Limit value and tap .
 9. Confirm settings and tap .
- ✓ A *SETTING SAVED* screen is temporarily displayed.

4.11 Display Settings

The display settings for your t:slim X2 pump includes Screen Timeout.

You can set the Screen Timeout to the length of time you want the screen to stay on before it automatically turns off. The default for the Screen Timeout is 30 seconds. The options are 15, 30, 60, and 120 seconds.

You can always turn the screen off before it automatically times out by pressing the **Screen On/Quick Bolus** button.

1. From the *Home* screen, tap **OPTIONS**.
2. Tap the **Down Arrow**.
3. Tap **Device Settings**.
4. Tap **Display Settings**.
5. Tap **Screen Timeout**.
6. Select preferred time and tap .

7. Tap the **Tandem logo** to return to the *Home* screen.

4.12 Sound Volume

The Sound Volume is preset to high. Sound Volume can be personalized for Alarms, Alerts, Reminders, Keypad, Bolus, Quick Bolus, and Fill Tubing. Options for Sound Volume include high, medium, low, and vibrate.

▲ PRECAUTION

DO NOT use the vibrate feature for alerts and alarms during sleep unless otherwise directed by your healthcare provider. Having the volume for alerts and alarms set to high will help ensure that you don't miss an alert or alarm.







1. From the *Home* screen, tap **OPTIONS**.
2. Tap the **Down Arrow**.
3. Tap **Device Settings**.
4. Tap **Sound Volume**.
5. Tap desired option. Use **Up/Down Arrow** to view additional options.





6. Select preferred volume.
7. Continue to make changes for all Sound Volume options by repeating steps 5 and 6.
8. Tap  when all changes are complete.
9. Tap the **Tandem logo** to return to the *Home* screen.

4.13 Turn Security PIN On or Off

The Security PIN is preset to off. With the Security PIN turned on, you cannot unlock and use the pump without entering the Security PIN. To turn on the Security PIN, follow these steps.

1. From the *Home* screen, tap **OPTIONS**.
2. Tap the **Down Arrow**.
3. Tap **Device Settings**.
4. Tap the **Down Arrow**.
5. Tap **Security PIN**.

6. Tap **Security PIN** to toggle the feature on.
 7. Tap  to create your Security PIN.
 8. Using the keypad, enter a number between four and six digits. A PIN may not begin with the number zero.
 9. Tap .
 10. Tap  to verify your Security PIN.
 11. Use the keypad to repeat and verify the new Security PIN.
 12. Tap .
 - ✓ A *PIN CREATED* screen is displayed.
 13. Tap  to turn the Security PIN on.
 14. Tap .
- It is possible to change your Security PIN or override an old Security PIN if you forget your Security PIN.

1. From the *Home* screen, tap **OPTIONS**.
2. Tap the **Down Arrow**.
3. Tap **Device Settings**.
4. Tap the **Down Arrow**.
5. Tap **Security PIN**.
6. Tap **Change Security PIN**.
7. Tap **OK**.
8. Using the keypad, enter the current Security PIN. If you forget your Security PIN, use the override code **314159**.
 - » The override PIN can be used as many times as needed and never resets or changes to another PIN. It can be used to unlock the pump when the Security PIN feature is on. If desired, you may use this as a valid Security PIN.
9. Tap .
10. Tap **OK** to enter a new Security PIN.
11. Use the keypad to enter a new Security PIN.
12. Tap .
13. Tap **OK** to verify your new Security PIN.
14. Use the keypad to repeat and verify the new Security PIN.
15. Tap .
- ✓ A *PIN UPDATED* screen is displayed.
16. Tap .

2 t:slim X2 Insulin Pump Features

CHAPTER 5

Infusion Site Care and Loading Cartridge

5.1 Infusion Site Selection and Care

▲ WARNING

ALWAYS use only cartridges and insulin infusion sets with matching connectors and follow their instructions for use. Failure to do so may result in over delivery or under delivery of insulin and may cause hypoglycemia (low BG) or hyperglycemia (high BG) events.

▲ WARNING

ALWAYS carefully follow the instructions for use accompanying your infusion set for proper insertion and infusion site care, as failure to do so could result in over delivery or under delivery of insulin or infection.

▲ WARNING

DO NOT place your infusion set on any scars, lumps, moles, stretch marks or tattoos. Placing your infusion set in these areas can cause swelling, irritation or infection. This can affect insulin absorption and cause hypoglycemia (low BG) or hyperglycemia (high BG) events.

▲ PRECAUTION

CHECK your infusion site daily for proper placement and leaks. **REPLACE** your infusion

set if you notice leaks around the site. Improperly placed sites or leaks around the infusion site can result in under delivery of insulin.

▲ PRECAUTION

DO NOT change your infusion set before bedtime or if you will not be able to test your BG 1–2 hours after the new infusion set is placed. It is important to confirm that the infusion set is inserted correctly and delivering insulin. It is also important to respond quickly to any problems with the insertion to ensure continued insulin delivery.

General Guidelines

Site Selection

- Your infusion set can be worn anywhere on your body that you would normally inject insulin. Absorption varies from site to site. Discuss options with your healthcare provider.
- The most commonly used sites are the abdomen, upper buttocks, hips, upper arms, and upper legs.
- The abdomen is the most popular site because of access to fatty

tissue. If using the abdominal area, **AVOID**:

- Areas that would constrict the site such as the belt line, waistline, or where you would normally bend.
- Areas 2 inches (5 cm) around your belly button.
- Any scars, moles, stretch marks, or tattoos.
- Areas within 3 inches (7.6 cm) of your CGM sensor site.

Site Rotation

▲ PRECAUTION

CHANGE your infusion set every 48–72 hours as recommended by your healthcare provider. Wash your hands with anti-bacterial soap before handling the infusion set and thoroughly clean the insertion site on your body to avoid infection. Contact your healthcare provider if you have symptoms of infection at your insulin infusion site.

- The infusion set must be replaced and rotated every 48–72 hours, or more often if needed.

- With experience, you will find areas that not only provide better absorption, but are more comfortable. Keep in mind, using the same areas may cause scarring or lumps which can affect insulin absorption.
- Consult your healthcare provider to establish a rotation schedule that best fits your needs.

Keep it Clean

- When changing your infusion set, use clean techniques to avoid an infection.
- Wash your hands, use antiseptic wipes or infusion site preparation products, and keep the area clean.
- Site preparation products that have both an antiseptic and an adhesive are encouraged.

5.2 Cartridge Instructions for Use

For complete cartridge labeling, consult the cartridge instructions for use included in the t:slim X2™ cartridge box.

Areas of Body for Infusion Set Insertion

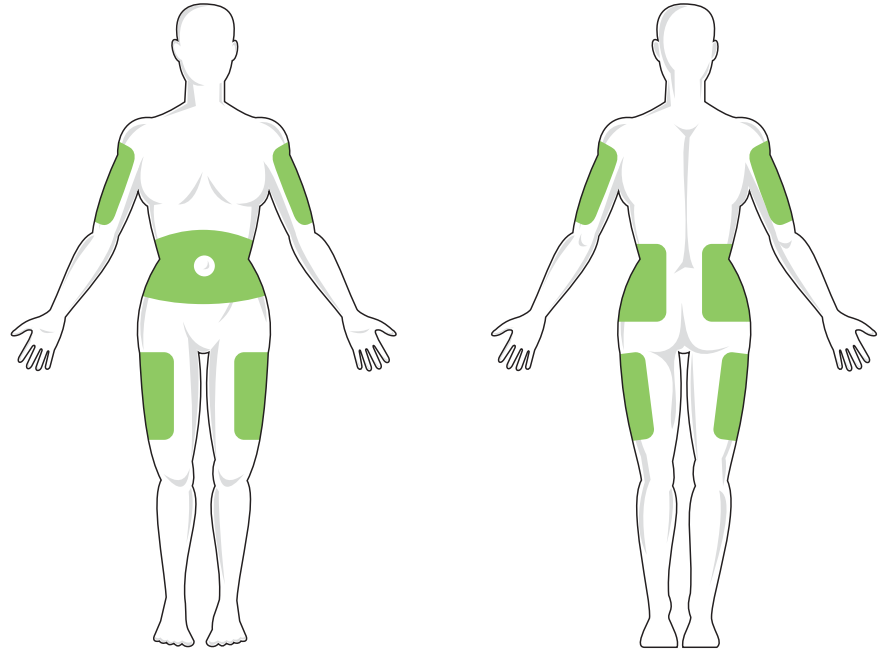

5.3 Filling and Loading a t:slim X2 Cartridge

This section describes how to fill the cartridge with insulin and load the cartridge into your t:slim X2 pump. The single-use disposable cartridge can hold up to 300 units (3.0 mL) of insulin.

⚠ WARNING

ONLY use U-100 insulins in your pump. Only U-100 Humalog and NovoLog have been tested and found to be compatible for use with the pump. The use of insulin with lower or higher concentration insulin may cause over delivery or under delivery of insulin. This can cause hypoglycemia (low BG) or hyperglycemia (high BG) events.

⚠ WARNING

ALWAYS use cartridges manufactured by Tandem Diabetes Care. Use of any other cartridge brand may result in over delivery or under delivery of insulin. This can cause hypoglycemia (low BG) or hyperglycemia (high BG) events.

⚠ WARNING

DO NOT reuse cartridges. Reuse of cartridges may result in over delivery or under delivery of

insulin. This can cause hypoglycemia (low BG) or hyperglycemia (high BG) events.

Start by preparing the following:

- 1 unopened cartridge
- 3.0 mL syringe and fill needle
- one vial of compatible insulin
- Alcohol prep swab
- 1 new infusion set
- infusion set instructions for use

🚩 NOTE

The pump will beep or vibrate, depending on your pump settings, while the cartridge is filling with insulin. To change the Fill Tubing sound setting, see [Section 11.3 t:slim X2 Sound Volume](#).

🚩 NOTE

The pump will beep or vibrate, depending on your pump settings, while the tubing is filling with insulin. To change the Fill Tubing sound setting, see [Section 4.12 Sound Volume](#).

🚩 NOTE

The pump will beep or vibrate, depending on your pump settings, while the cartridge is filling

with insulin. To change the Fill Tubing sound setting, see [Section 11.3 t:slim X2 Sound Volume](#).

🚩 NOTE

DO NOT remove the used cartridge from the pump during the load process until prompted on the pump screen.

The illustration identifies the connector and insulin fill port used in the cartridge filling process.

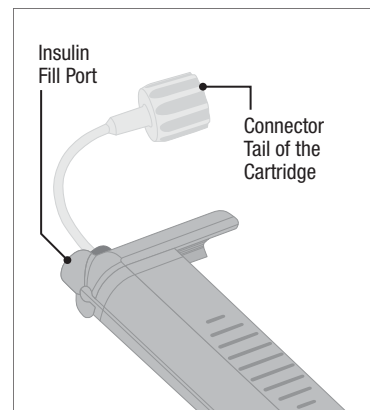

▲ PRECAUTION

CHANGE your cartridge every 48–72 hours as recommended by your healthcare provider. Wash your hands with anti-bacterial soap before handling the infusion set and thoroughly clean the insertion site on your body to avoid infection. Contact your healthcare provider if you have symptoms of infection at your insulin infusion site.

Instructions for Drawing Insulin from Vial into Syringe

The fill estimate displayed on the pump is the amount of insulin available for delivery. It does not include insulin needed to fill the tubing (up to 30 units) and a small amount of insulin that is not available for delivery. When filling the syringe, add approximately 45 units to the amount of insulin you want available for delivery.

For example, the pump requires a minimum of 50 units available for delivery after fill tubing has been completed. Fill the syringe with approximately 95 units to have enough to fill your tubing and still have 50 units available for delivery.

1. Inspect the needle and syringe package for any signs of damage. Discard any damaged product.
2. Wash your hands thoroughly.
3. Wipe the rubber septum of the insulin vial with an alcohol swab.
4. Remove the needle and syringe from their packaging. Securely twist needle onto syringe. Safely remove protective cap from needle by pulling outward.
5. Draw air into syringe up to the amount of insulin desired.

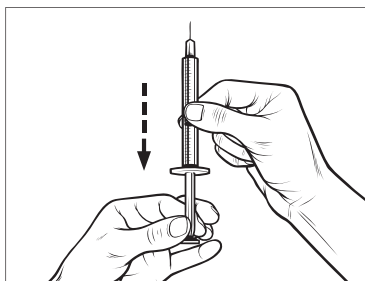

6. With insulin vial upright, insert needle into vial. Inject air from

syringe into vial. Maintain pressure on syringe plunger.

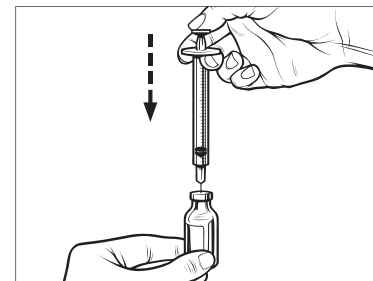

7. With needle still inserted into vial, turn vial and syringe upside down. Release syringe plunger. Insulin will begin to flow from the vial into the syringe.

8. Slowly pull back the plunger to the desired amount of insulin.

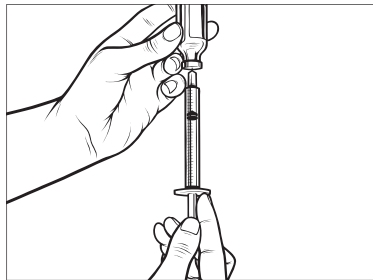

9. While the filling needle is still in the vial and upside down, tap the syringe so that any air bubbles rise to the top. Then slowly push the plunger upwards, forcing any air bubbles back into the vial.

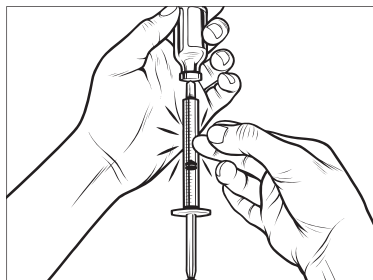

10. Check the syringe for air bubbles and do one of the following:

- If there are air bubbles present, repeat step 9.
- If no air bubbles are present, remove the filling needle from the vial.

Instructions for Filling the Cartridge

1. Inspect the cartridge package for any signs of damage. Discard any damaged product.
2. Open the package and remove the cartridge.
3. Hold the cartridge upright and gently insert the needle into the white insulin fill port on the cartridge. The needle is not intended to go all the way in, so do not force it.

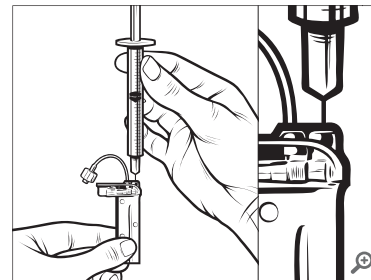

4. Keeping the syringe vertically aligned with the cartridge, and the needle inside the fill port, pull back on the plunger until it is fully retracted. This will remove any residual air from the cartridge. Bubbles will rise toward the plunger.

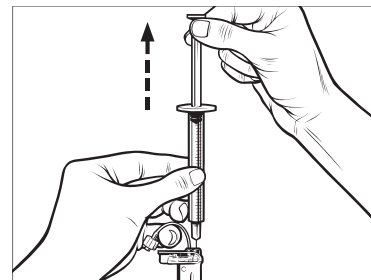

5. Make sure the needle is still in the fill port and release the plunger. Pressure will pull the plunger to its neutral position but it will **NOT** push any air back inside the cartridge.

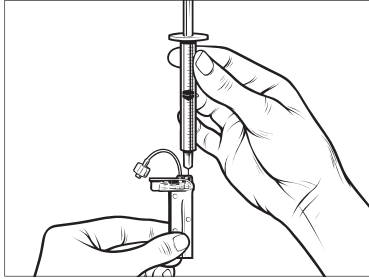

6. Withdraw the needle from the fill port.
7. Turn the syringe upright and pull down on the plunger. Flick the barrel to make sure that any air bubbles rise to the top.

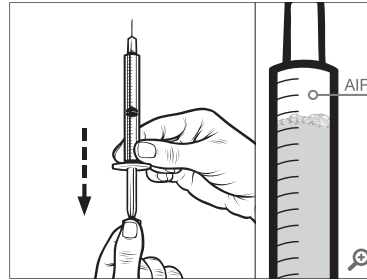

8. Gently press on the plunger to remove air bubbles until insulin fills the needle hub and you see a drop of insulin at the tip of the needle.

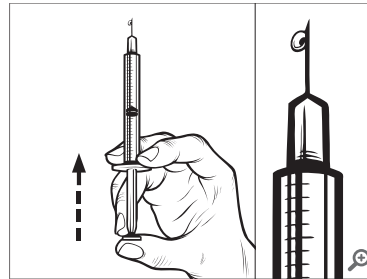

9. Re-insert the needle in the fill port and slowly fill the cartridge with insulin. It is normal to feel some

back pressure as you slowly press on the plunger.

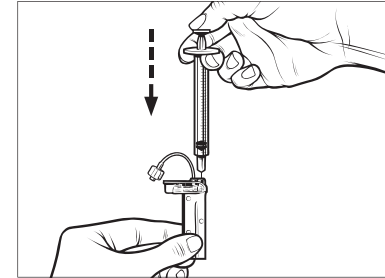

10. Maintain pressure on the plunger while you remove the needle from the cartridge. Check the cartridge for leaks. If you detect insulin leaking, discard the cartridge and repeat entire process with a new cartridge.
11. Always dispose of used needles, syringes, cartridges, and infusion sets following the instructions from your healthcare provider.

Instructions on How to Install a Cartridge

If this is the very first time you are loading the cartridge, remove the shipping canister (which is not for human use) from the back of the pump.

1. From the *Home* screen, tap **OPTIONS**.
 2. Tap **Load**.
- ✓ During the load sequence, the **Tandem logo** is disabled.

Tapping it will not return to the *Home* screen.

3. Tap **Change Cartridge**.
4. Screen will display that all insulin deliveries will be stopped. Tap  to continue.

NOTE

This screen will not be displayed if this is the first time loading a new cartridge and you have not started actively pumping.

5. Disconnect the infusion set from your body and tap  to continue.

- ✓ *Preparing for Cartridge* screen is displayed.

6. Remove the used cartridge. If needed, place the cartridge removal tool or the edge of a coin in the slot at the bottom of the cartridge and twist to aid in the removal of the cartridge.

7. Place bottom of the cartridge at the end of the pump. Make sure cartridge is lined up to both guide tracks.

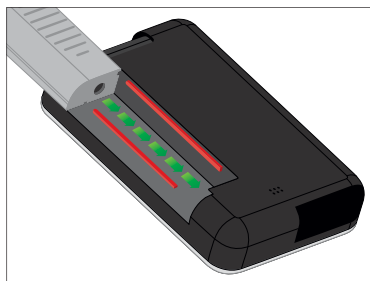

8. Push on the circular fill port next to the cartridge tubing to slide the

cartridge onto the pump. Tap the **UNLOCK** icon when completed.

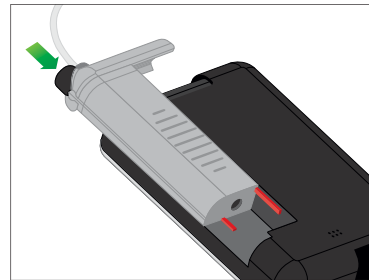

9. Tap  to continue.

- ✓ *Detecting Cartridge* screen is displayed.

- ✓ After completing the cartridge change, the pump will automatically prompt you to fill the tubing.

10. Tap  to fill the tubing.

WARNING

DO NOT remove or add insulin from a filled cartridge after loading onto the pump. This will result in an inaccurate display of the insulin level on the *Home* screen and you could run out of insulin before the pump detects an empty

cartridge. This can cause very high BG, or Diabetic Ketoacidosis (DKA).

5.4 Filling Tubing

Filling the Infusion Set Tubing with Insulin

▲ WARNING

NEVER fill your tubing while your infusion set is connected to your body. Always ensure that the infusion set is disconnected from your body before filling the tubing. Failure to disconnect your infusion set from your body before filling the tubing can result in over delivery of insulin. This can cause hypoglycemia (low BG) events.

This section describes how to fill the infusion set tubing with insulin after you change the cartridge.

■ NOTE

The pump will beep or vibrate, depending on your pump settings, while the tubing is filling with insulin. To change the Fill Tubing sound setting, see [Section 4.12 Sound Volume](#).

To fill the tubing without changing the cartridge, from the *Home* screen tap

OPTIONS, tap **Load**, tap **Fill Tubing** and then follow the instructions.

- Tap **NEW** if you installed a new cartridge.
- Tap **FILL** if you did not install a new cartridge and want to continue with filling the tubing.

▲ PRECAUTION

ALWAYS remove all air bubbles from the cartridge before beginning insulin delivery. Ensure there are no air bubbles when drawing insulin into the filling syringe, hold the pump with the white fill port pointed up when filling the tubing, and ensure that there are no air bubbles in the tubing when filling. Air in the system takes space where insulin should be and can affect insulin delivery.

▲ PRECAUTION

CHECK your infusion set tubing daily for any leaks, air bubbles, or kinks. Air in the tubing, leaks in the tubing, or kinked tubing may restrict or stop insulin delivery and result in under delivery of insulin.

1. Verify that the infusion set is disconnected from your body.

2. Ensure that the new infusion set package is not damaged, and remove the sterile tubing from the package. If the package is damaged or opened, discard of properly and use another tubing set.
3. Be careful to keep the tubing connector away from unclean areas.
4. Attach the infusion set tubing to the tubing connector on the cartridge. Twist clockwise until finger tight and then twist another quarter of a turn to ensure a secure connection.

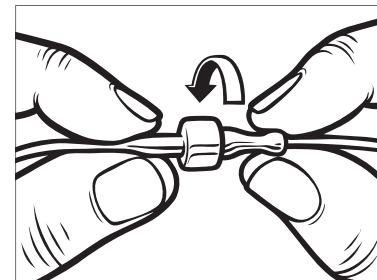

▲ WARNING

ALWAYS twist the tubing connector between the cartridge tubing and the infusion set tubing an extra quarter of a turn to ensure a secure connection. A loose connection can cause insulin to leak, resulting in under delivery of insulin. This can cause hyperglycemia (high BG) events.

5. Tap .
6. Hold the pump vertically to ensure any air in the cartridge will be dispelled first. Tap **START**. The pump will beep and vibrate regularly while the tubing is being filled.

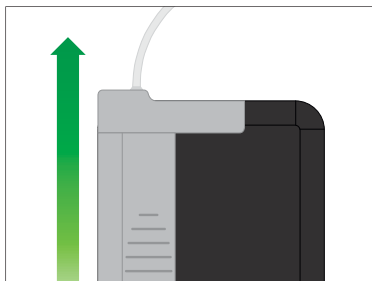

- ✓ *Starting Fill* screen is displayed.

The following are approximate amounts of insulin to fill different tubing lengths:

- 15–20 units for 23 inch (60 cm) tubing
 - 20–25 units for 32 inch (80 cm) tubing
 - 25–30 units for 43 inch (110 cm) tubing
7. Tap **STOP** after 3 drops of insulin are seen at the end of the infusion set tubing.
 - ✓ *Stopping Fill* screen is displayed.
 - ✓ *Detecting Insulin* screen is displayed.
 8. Verify that drops are seen and tap **DONE**.
 - If you do not see drops, tap **FILL**. The *Fill Tubing* screen appears, repeat steps 3 to 5 until you see 3 drops of insulin at the end of the tubing.

- The tubing may be filled with a maximum of 30 units of insulin during each fill cycle. If you do not tap **STOP**, a notification screen will appear letting you know that the maximum amount has been filled. Do one of the following:
 - a. If you are finished filling the tubing, tap **DONE**.
 - b. If you want to fill the tubing with more than 30 units, tap **FILL** to go back to the *Fill Tubing* screen.
- ✓ *Fill Tubing is complete* screen is temporarily displayed.

NOTE

After tubing fill is complete, when the pump returns to the *Home* screen, an estimate of how much insulin is in the cartridge is displayed in the upper right portion of the screen. You will see one of the following on the screen:

- + 40 u More than 40 units detected in the cartridge
- + 60 u More than 60 units detected in the cartridge

- + 120 u More than 120 units detected in the cartridge
- + 180 u More than 180 units detected in the cartridge
- + 240 u More than 240 units detected in the cartridge

After 10 units are delivered, an actual number of units remaining in the cartridge will be displayed on the *Home* screen

The amount of insulin remaining displayed on the *Home* screen will decrease 5 units at a time (for example, you will see 140, 135, 130, 125). When less than 40 units remain, it will begin decreasing 1 unit at a time (for example, you will see 40, 39, 38, 37) until there is 1 unit remaining.

- ✓ A screen will display to instruct you to insert a new infusion set and connect to the filled tubing.

5.5 Filling Cannula

Filling the Infusion Set Cannula with Insulin

This section describes how to fill the infusion set cannula with insulin after you fill the tubing.

To fill the cannula without filling the tubing, from the *Home* screen, tap **OPTIONS**, tap **Load**, tap **Fill Cannula** and then follow the instructions below.

If you are using a steel needle infusion set, there is no cannula; skip this section.

To Fill the Cannula:

1. Tap **Fill Cannula**.
 2. Insert a new infusion set and connect filled tubing to site, then tap .
 3. Tap **Edit Fill Amount**.
- ✓ The cannula fill amount displayed is based on your last cannula fill

amount. Filling stops at this amount.



4. Select amount needed for cannula fill.
 - See your infusion set instructions for use for proper cannula fill amount.
 - If the amount needed is not listed, tap **Other amount** and use the on-screen keypad to enter a value between 0.1 to 1.0 unit.
 5. Tap .
- ✓ The *STARTING FILL* screen is displayed.
 - ✓ After fill is complete, *STOPPING FILL* screen is displayed.
- NOTE**
- You can tap **STOP** at any time during the fill process if you want to stop filling the cannula.
- ✓ The screen will return to the *Load* menu if the Site Reminder is turned off.





- Tap  to resume insulin if finished. Or tap **Site Reminder** to set reminder. If Site Reminder is on, the pump will automatically display the *Site Reminder* screen (see the next section).

5.6 Setting Site Reminder

This section describes how to set the Site Reminder after you fill the cannula.

To set the Site Reminder without filling the cannula, from the *Home* screen, tap **OPTIONS**, tap **Load**, tap **Site Reminder** then follow the instructions below.

- Tap  if correct. Tap **Edit Reminder** if settings need to be changed.
- Tap **Remind Me In** and select the number of days (1–3).
 - ✓ The default for the Site Reminder is set for 3 days
- Tap **Remind Me At**. Use the on-screen keypad to enter time and tap .

- Tap **Time of Day** to change AM or PM, if applicable. Tap .
- Verify Site Reminder is set correctly and tap .
 - ✓ *Setting Saved* screen is displayed.
 - ✓ *Load* screen is displayed.
- Tap .
- ✓ A reminder to test BG in 1 to 2 hours will display.
- Tap .

NOTE

If this is the first time using your pump and a Personal Profile has not been defined, a screen will notify you that a profile must be activated to resume insulin. Tap **CLOSE**.

- ✓ *RESUMING INSULIN* screen is temporarily displayed.

NOTE

Basal-IQ™ technology will continue to operate while changing a cartridge. If you complete a cartridge change and resume insulin while Basal-IQ technology is

suspending insulin, insulin will resume until the next five minute CGM reading. At this time the pump will resume normal operation.

2 t:slim X2 Insulin Pump Features

CHAPTER 6

Personal Profiles

6.1 Personal Profiles Overview

▲ WARNING

DO NOT start to use your pump before consulting with your healthcare provider to determine which features are most appropriate for you. Only your healthcare provider can determine and help you adjust your basal rate(s), carb ratio(s), correction factor(s), target BG, and duration of insulin action. In addition, only your healthcare provider can determine your CGM settings and how you should use your sensor trend information to help you manage your diabetes. Incorrect settings can result in over delivery or under delivery of insulin. This can cause hypoglycemia (low BG) or hyperglycemia (high BG) events.

A Personal Profile is a group of settings that define basal and bolus delivery within specific time segments throughout a 24-hour period. Each profile can be personalized with a name. Within a Personal Profile the following can be set:

- **Timed Settings:** Basal Rate, Correction Factor, Carb Ratio and Target BG.

- **Bolus Settings:** Insulin Duration and Carbohydrates setting (on/off).

The t:slim X2 pump uses the settings in your active profile to calculate the delivery of basal insulin, food boluses and correction boluses based on your target BG. If you only define a basal rate in Timed Settings, your pump will only be able to deliver basal insulin and standard and extended boluses. Your pump will not calculate correction boluses.

Up to six different Personal Profiles can be created and up to 16 different time segments can be set in each Personal Profile. Having several Personal Profiles provides more flexibility for your body and lifestyle. For example, you could have “Weekday” and “Weekend” profiles if you have different insulin delivery needs on weekdays and weekends, based on schedule, food intake, activity, etc.

6.2 Creating a New Profile

Creating Personal Profiles

You can create up to six Personal Profiles; however, only 1 can be active at a time. In the *Personal Profiles* screen, the active profile is positioned at the top of the list and is marked as on. When you create a Personal Profile, you can set any or all of the following Timed Settings:

- Basal Rate (your basal rate in units/hr)
- Correction Factor (amount 1 unit of insulin lowers BG)
- Carb Ratio (grams of carbs covered by 1 unit of insulin)
- Target BG (your ideal BG level, measured in mg/dL)

Although you do not need to define every setting, some pump features require certain settings to be defined and activated. When you are creating a new profile, your pump prompts you to set up any required settings before you can continue.

The ranges you can set for Timed Settings are:

- Basal (range: 0 and 0.1 to 15 units/hr)

NOTE

The basal rate may not exceed the Basal Limit set in Pump Settings (Section 4.10 Basal Limit). If you set up your Basal Limit after you have set any of your Personal Profiles, you cannot set your Basal Limit lower than any of your existing basal rates.

- Correction Factor (range: 1 unit:1 mg/dL to 1 unit:600 mg/dL)
- Carb Ratio (range: 1 unit:1 gram to 1 unit:300 grams)

Below a carb ratio of 1:10, increments can be entered in 0.1 g. For example a carb ratio of 1:8.2 can be programmed.

- Target BG (range: 70 mg/dL to 250 mg/dL)

In addition, you can set any or all of the following Bolus Settings:

- Carbs (on indicates entering grams of Carb; off indicates entering units of insulin)
- Insulin Duration (how long a bolus lowers your BG)

The default settings and ranges for Bolus Settings are as follows:

- Carbs (default: off if no Carb Ratio is defined)
- Insulin Duration (default: 5 hrs; range: 2 to 8 hrs)



Insulin Duration and Insulin on Board (IOB)

Your pump remembers how much insulin you have taken from previous boluses. It does this by relying on the insulin duration. The insulin duration reflects the amount of time that insulin is actively lowering your BG.

Consult your healthcare provider to accurately set your insulin duration.

While the insulin duration setting reflects how long insulin from previous boluses lowers your BG, the IOB feature reflects how much insulin is

remaining in your body from previous boluses. IOB is always displayed on the *Home* screen and is used in bolus delivery calculations when applicable. When a glucose value is entered during bolus programming, your pump will consider any active IOB and calculate an adjusted bolus if necessary.

1. From the *Home* screen, tap **OPTIONS**.
2. Tap **My Pump**.
3. Tap **Personal Profiles**.
4. Tap  to create a new profile.
5. Using the on-screen keypad, enter a profile name (up to 16 characters) and tap .

To use the letter keypad, tap once for first letter displayed, 2 quick taps for middle letter; and 3 quick taps for the third letter.

6. Tap **Press to Set Up** to begin setting insulin delivery settings.

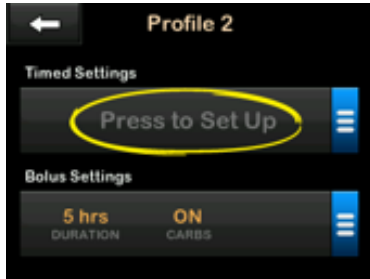

6.3 Programming a New Personal Profile

Once the Personal Profile has been created, the settings must be programmed. The first time segment will start at midnight.

- You must program a basal rate in order to have a Personal Profile that you can activate.
- You must set a basal rate, correction factor, carb ratio, and target BG in order to turn Basal-IQ™ technology on.

- Be sure to tap  after entering or changing a value.

⚠ PRECAUTION

ALWAYS confirm that the decimal point placement is correct when entering your Personal Profile information. Incorrect decimal point placement can prevent you from getting the proper insulin amount that your healthcare provider has prescribed for you.





Timed Settings







1. Once the new profile has been created, Tap **Basal**.
2. Using the on-screen keypad, enter your basal rate and tap .

NOTE

If you have previously set a Basal Limit in the Pump Settings, then the Basal rate entered here must be lower than the Basal Limit entered in the Pump Settings.

3. Tap **Correction Factor**.
4. Using the on-screen keypad, enter your correction factor (the mg/dL that 1 unit of insulin will lower BG) and tap .
5. Tap **Carb Ratio**.
6. Using the on-screen keypad, enter your insulin-to-carbohydrate ratio (the grams of carbohydrate to be covered by 1 unit of insulin) and tap .
7. Tap **Target BG**.
8. Using the on-screen keypad, enter your target BG and tap .
9. Review entered values and tap .
10. Confirm Settings.

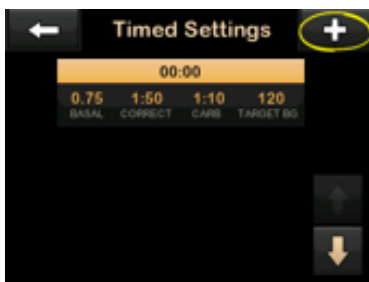

- Tap  if entered data is correct.
 - Tap  to make changes.
11. Tap  to set the Bolus Settings or tap  to create additional time segments.



Adding More Time Segments

When adding more time segments, any settings that you entered in the previous time segment are copied and appear in the new segment. This allows you to simply adjust only the specific settings you want, rather than have to enter them all over again.

1. On the *Add Segment* screen, tap **Start Time**.

2. Using the on-screen keypad, enter the time (hour and minutes) that you want the segment to begin, and tap .
3. On the *Add Segment* screen, tap **Time of Day** to select AM or PM, if applicable.
- ✓ Once a time segment is set beyond 12:00 PM, the default will change to PM.
4. Tap .
5. Repeat steps 1 to 6 from the [Creating a New Profile](#) section above for each segment you want to create (up to 16).

To find time segments in the list that are not displayed on the first screen, tap the **Down Arrow**.

Bolus Settings

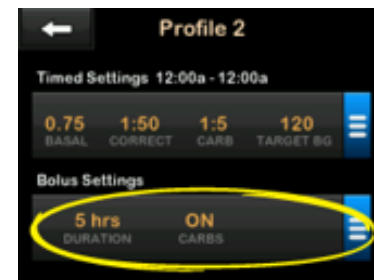

1. Tap the **Bolus Settings** panel.

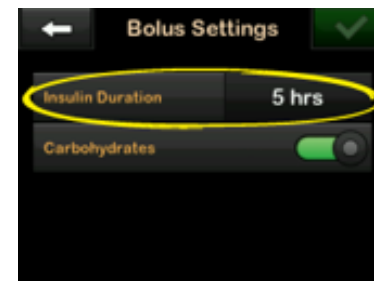

2. Tap **Insulin Duration**.



3. Using the on-screen keypad, enter the desired time for the duration of insulin action (2–8 hrs) and tap .

4. Tap **Carbohydrates** to turn on and use the carb ratio when calculating boluses.
5. Review entered values and tap .
6. Confirm Settings.
 - Tap  if entered data is correct.
 - Tap  to make changes.
7. Tap **Tandem logo** to return to the *Home* screen.

Adding More Personal Profiles

1. From the *Home* screen, tap **OPTIONS**.
2. Tap **My Pump**.
3. Tap **Personal Profiles**.
4. Tap .
5. Name the new profile and repeat steps for Timed Settings and Bolus Settings.

NOTE

If the first profile you created is programmed using a carb ratio, any new profile will also have the Carbohydrates option turned on, but a ratio will still need to be defined.







6.4 Editing or Reviewing an Existing Profile

1. From the *Home* screen, tap **OPTIONS**.
2. Tap **My Pump**.
3. Tap **Personal Profiles**.
4. Tap the name of the Personal Profile to edit or review.
5. Tap **Edit**.



NOTE

To review settings but bypass editing the settings, skip the remaining steps in this section. You can tap  to navigate to the Personal Profiles list or tap the **Tandem logo** to return to the *Home* screen.

6. Tap **Timed Settings** panel.

7. Tap the desired time segment to edit.
8. Tap **Basal, Correction Factor, Carb Ratio** or **Target BG** to make changes as needed and use the on-screen keypad to enter changes. Tap .
9. View recent changes and tap .
10. Confirm Settings.
 - Tap  if entered data is correct.
 - Tap  to make changes.
11. Edit other time segments within the Timed Settings by tapping on them and using the same steps described above.
12. Tap  after editing all of the time segments.
13. Tap the **Bolus Settings** panel to change Insulin Duration or Carbohydrates as needed. Use the on-screen keypad to enter desired changes. Tap .

14. Confirm Settings.

- Tap  if entered data is correct.
- Tap  and make changes.

15. Tap **Tandem logo** to return to the *Home* screen.**NOTE**

To Add a time segment, tap  and enter the desired start time.



NOTE

To Delete a time segment, tap on the X to the left of the time segment and tap  to confirm.

6.5 Duplicating an Existing Profile

1. From the *Home* screen, tap **OPTIONS**.
2. Tap **My Pump**.
3. Tap **Personal Profiles**.
4. Tap the name of the Personal Profile to duplicate.

5. Tap **Duplicate**.

6. Confirm profile to duplicate by tapping .
 7. Using the on-screen keypad, enter the name (up to 16 characters) for the new profile and tap .
- ✓ *Profile Duplicated* screen is displayed.
 - ✓ A new Personal Profile will be created with the same settings as the profile copied.
8. Tap the **Timed Settings** or **Bolus Settings** panel to make changes to the new profile.

6.6 Activating an Existing Profile

1. From the *Home* screen, tap **OPTIONS**.
2. Tap **My Pump**.
3. Tap **Personal Profiles**.

4. Tap the name of the Personal Profile to be activated.

- The **Activate** and **Delete** options are disabled for the active profile because the profile is already activated. You cannot delete a profile until you have activated another profile.
 - If you have only 1 profile defined, you do not need to activate it (that profile is automatically activated).
5. Tap **Activate**.
 - ✓ A screen to confirm the activation request is displayed.
 6. Tap .
 - ✓ *Profile Activated* screen is displayed.

6.7 Renaming an Existing Profile

1. From the *Home* screen, tap **OPTIONS**.
2. Tap **My Pump**.

3. Tap **Personal Profiles**.
4. Tap the name of the Personal Profile to be renamed.
5. Tap **Down Arrow**, and then **Rename**.
6. Using the on-screen keypad, rename the profile name (up to 16 characters) and tap .
7. Tap **Tandem logo** to return to the *Home* screen.

6.8 Deleting an Existing Profile

1. From the *Home* screen, tap **OPTIONS**.
2. Tap **My Pump**.
3. Tap **Personal Profiles**.
4. Tap the name of the Personal Profile to be deleted.

NOTE

The active Personal Profile cannot be deleted.

5. Tap **Delete**.
6. Tap .
- ✓ *Profile Deleted* screen is displayed.
7. Tap the **Tandem logo** to return to the *Home* screen.

6.9 Starting a Temporary Basal Rate

A Temp Rate is used to increase or decrease (by percentage) the current basal rate for a period of time. This feature can be helpful for situations such as exercise or illness.

When you enter the *Temp Rate* screen, the default values are 100% (current basal rate) and a Duration of 0:15 min. The Temp Rate can be set from a minimum of 0% of current basal rate to a maximum of 250% of current basal rate in increments of 1%.

Duration can be set from a minimum of 15 minutes to a maximum of 72 hours in increments of 1 minute.

If you program a Temp Rate greater than 0% but less than the minimum allowable basal rate of 0.1 units/hr, you will be notified that the selected rate is too low and that it will be set to the minimum allowable rate for delivery.



If you program a Temp Rate more than the maximum allowable basal rate of 15 units/hr, or more than your Basal Limit set up in the Pump Settings, you will be notified that the selected rate is too high and that it will be set to the maximum allowable rate for delivery.

NOTE

Use of Basal-IQ technology does not cancel or pause a Temp Rate time period, even if Basal-IQ technology suspends insulin delivery, unless you manually stop the Temp Rate.

1. From the *Home* screen, tap **OPTIONS**.
2. Tap **Temp Rate**.
3. Tap **Temp Rate** again.
4. Using the on-screen keypad enter desired percentage. The current rate is 100%. An increase is greater

than 100% and decrease is less than 100%.

5. Tap .
6. Tap **Duration**. Using the on-screen keypad enter desired length of time for Temp Rate. Tap .

You can always tap **View Units** to see the actual units to be delivered.

7. Verify settings and tap .
- ✓ The *TEMP RATE STARTED* screen is temporarily displayed.
 - ✓ The *Lock* screen will be displayed with the icon indicating a Temp Rate is active.
 - An T in an orange box means a Temp Rate is active.
 - A T in a red box means a Temp Rate of 0 is active.



NOTE

If Basal-IQ technology suspends insulin delivery while a Temp Rate is active, the Temp Rate timer will remain active. The Temp Rate will be

resumed when insulin delivery is resumed as long there is time remaining on the Temp Rate timer.

6.10 Stopping a Temp Rate

To stop an active temp rate:

1. From the *Home* screen, tap **OPTIONS**.
 2. On the *Options* screen, tap  (stop icon) on the right side of Temp Rate.
 3. On the confirmation screen, tap .
- ✓ The *TEMP RATE STOPPED* screen appears before returning to the *Options* screen.

This Page is Intentionally Left Blank

2 t:slim X2 Insulin Pump Features

CHAPTER 7

Manual Bolus

7.1 Manual Bolus Overview

▲ WARNING

DO NOT deliver a bolus until you have reviewed the calculated bolus amount on the pump display. If you deliver an insulin amount that is too high or too low, this could cause hypoglycemia (low BG) or hyperglycemia (high BG) events. You can change the amount of insulin before you deliver your bolus.

▲ WARNING

Delivering large boluses, or delivering multiple boluses back to back may cause hypoglycemia (low BG) events. Pay attention to IOB and the bolus calculator recommended dose before delivering large or multiple boluses.

▲ WARNING

If your BG does not respond as anticipated after delivering a bolus, it is recommended that you check your infusion set for an occlusion, air bubbles, or for leaks or cannula dislodgement. If the condition persists, call Customer Technical Support or seek medical attention as required.

A bolus is a quick dose of insulin that is usually delivered to cover food eaten or to correct high glucose.

The minimum bolus size is 0.05 units. The maximum bolus size is 25 units. If you attempt to deliver a bolus that is larger than the amount of insulin in the cartridge, a message screen appears indicating that there is not enough insulin to deliver the bolus.

Your t:slim X2™ pump offers you the ability to deliver different boluses to cover carbohydrate intake (food bolus) and bring your BG back to target (correction bolus). Food and correction boluses can also be programmed together.

If Carbohydrates is turned on in your active personal profile, you will enter grams of carbohydrate and the bolus will be calculated using your Carb Ratio.

If Carbohydrates is turned off in your active personal profile, you will enter units of insulin to request the bolus.

If Basal-IQ™ technology is enabled and has suspended insulin delivery during a standard or quick bolus, all bolus deliveries will continue until completed. A new bolus cannot be started until insulin is resumed.

▲ PRECAUTION

CHECK your pump's settings regularly to ensure they are correct. Incorrect settings can result in over delivery or under delivery of insulin. Consult your healthcare provider as needed.

7.2 Correction Bolus Calculation

Once the pump knows your glucose value, it will determine whether to recommend a correction bolus to be added to any other bolus requested on the *Bolus* screen.

When your glucose value is:

- Above Target BG: the insulin for the food bolus and the correction bolus will be added together. If IOB is present, it will only be used in the calculation of the correction portion of the bolus.
- Between 70 mg/dL and Target BG: You will be given an option to reduce the food bolus to correct for the lower glucose. In addition, if IOB is present, it will also be used to reduce the bolus calculation.

- Below 70 mg/dL: The food bolus will be reduced to automatically correct for the low glucose value. In addition, if IOB is present, it will also be used to reduce the bolus calculation.

Always treat hypoglycemia (low BG) with fast-acting carbohydrates according to the instructions of your healthcare provider and then re-test your BG to ensure that the treatment was successful.

Glucose Value Manual Entry

You will need to enter your glucose value into the pump manually before advancing to the *Correction Bolus* screens. You can use the glucose value from your CGM or from your BG meter.

- From the *Home* screen tap **BOLUS**.

- Tap **Add BG**.

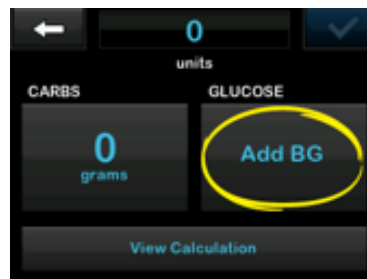

- Using the on-screen keypad, enter your glucose value and tap . Once is tapped, the glucose value is saved in your pump history whether or not a bolus is delivered.
- Follow the steps in the appropriate Target section below depending on the results of your glucose value.

Above Target

If your BG or sensor glucose value is above your Target BG, the pump presents you with the option for the

pump to calculate and add a correction bolus to any other bolus you request.

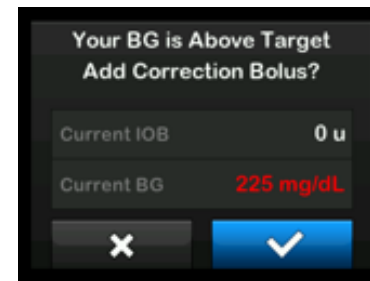

- To accept the correction bolus press . A correction bolus is calculated and will be added to any food bolus you request on the *Bolus* screen.
- To decline the correction bolus, press . No correction bolus will be added to any food bolus you request on the *Bolus* screen.

Below Target

If your BG or sensor glucose value is below your Target BG, the pump presents you with the option for the pump to calculate and subtract a

correction bolus from any other bolus you request.

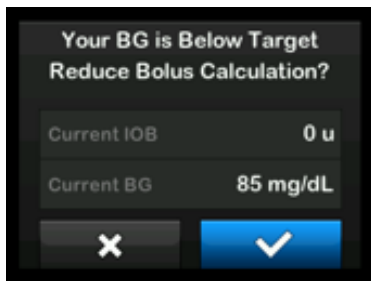

- To accept the correction bolus press . A correction bolus is calculated and will be subtracted from any food bolus you request on the *Bolus* screen.
- To decline the correction bolus, press . No correction bolus will be subtracted from any food bolus you request on the *Bolus* screen.

Within Target

If your BG or sensor glucose value is the same value as your Target BG, no *Correction Bolus* screen is displayed.

7.3 Bolus Override

You can override the calculated bolus by tapping on the calculated units value and entering the units of insulin you want delivered. The bolus override is always active.

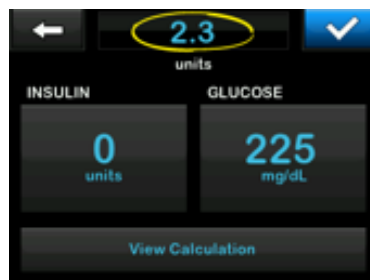

7.4 Food Bolus Using Units

If bolusing using a carb ratio, skip to the section [Section 7.5 Food Bolus Using Grams](#).

1. From the *Home* screen, tap **BOLUS**.
2. Tap **0 units**.





3. Using the on-screen keypad enter units of insulin to be delivered, then tap .

▲ WARNING

ALWAYS confirm that the decimal point placement is correct when entering bolus information. Incorrect decimal point placement can prevent you from getting the proper amount of insulin that your healthcare provider has prescribed for you.



4. Tap to confirm the units of insulin to be delivered.
 5. Confirm Request.
 - Tap if entered data is correct.
 - Tap to go back to make changes or view calculations.
 6. Tap .
- ✓ The *BOLUS INITIATED* screen is temporarily displayed.

7.5 Food Bolus Using Grams

1. From the *Home* screen, tap **BOLUS**.
2. Tap **0 grams**.
3. Using the on-screen keypad enter grams of carb and tap .
 - To add multiple carb values enter first value, then tap , enter second value, tap . Continue until done.
 - To clear the value entered and start over, tap the  back arrow.
4. Check that the grams of carb are entered in the correct location on the screen.
5. Tap  to confirm the units of insulin to be delivered.

You can always tap **View Calculation** to display the *Delivery Calculation* screen.

6. Confirm Request.

- Tap  if entered data is correct.
- Tap  to go back to make changes or view calculations.

7. Tap .



- ✓ The *BOLUS INITIATED* screen is temporarily displayed.

7.6 Extended Bolus

The Extended Bolus feature allows you to deliver part of the bolus now and part of the bolus slowly over a period of up to 8 hours. This can be helpful for high fat meals such as pizza or if you have gastroparesis (delayed stomach emptying).



When extending a bolus, any correction bolus amount will always be given in the *DELIVER NOW* portion. Talk with your healthcare provider to determine if this feature is appropriate for you, as well as for recommendations on the split between now and later and the duration for the later portion.

Only one extended bolus can be active at any given time. However, if the *DELIVER LATER* portion of an extended bolus is active, you can request another standard bolus.

1. From the *Home* screen, tap **BOLUS**.
2. Tap **0 grams** (or **0 units**).
3. Using the on-screen keypad enter grams of carb (or units of insulin). Tap .
4. If desired, tap **Add BG** and using the on-screen keypad enter a BG or sensor glucose value. Tap .
5. Tap  to confirm the units of insulin to be delivered.

You can always tap **View Calculation** to display the *Delivery Calculation* screen.

6. Confirm Request.
 - Tap  if entered data is correct.

- Tap  to go back to make changes or view calculations.
7. Tap **EXTENDED** to turn on the extended feature, then tap .
 8. Tap **50%** under DELIVER NOW to adjust the percentage of the food bolus that is to be delivered immediately.



The percentage value for DELIVER LATER is automatically calculated by the pump. The default is 50% NOW and 50% LATER. The default for DURATION is 2 hours.

9. Use the on-screen keypad to enter the percentage of the bolus to DELIVER NOW and tap .



For the DELIVER NOW portion, the minimum amount is .05 units. If the DELIVER NOW portion is less than .05 units, you will be notified and the DELIVER NOW portion will be set to .05 units.

The DELIVER LATER portion of the extended bolus also has minimum and maximum rates. If you program

a DELIVER LATER rate outside of these limits, you are notified and the duration of the DELIVER LATER portion is adjusted.

10. Tap **2 hrs** under DURATION.
11. Use the on-screen keypad to adjust the length of time the bolus is to be delivered, then tap .
12. Tap .

You can always tap **View Units** to display the breakdown of units to be delivered NOW versus LATER.

13. Confirm Request.
 - Tap  if entered data is correct.
 - Tap  to go back to make changes or view calculations.

14. Tap .

15. The *BOLUS INITIATED* screen is temporarily displayed.

Only one extended bolus can be active at any given time. However, if the

DELIVER LATER portion of an extended bolus is active, you can request another standard bolus.

NOTE

If Basal-IQ technology is on and has suspended insulin delivery during an extended bolus, all remaining bolus insulin will be canceled. If desired, a new bolus must be initiated after insulin delivery has been resumed.

7.7 Max Bolus

The Max Bolus setting allows you to set a limit to the maximum insulin delivery amount for a single bolus.

The default setting for Max Bolus is 10 units, but can be set to any value between 1 to 25 units. To adjust the Max Bolus setting, follow these steps.

1. From the *Home* screen, tap **OPTIONS**.
2. Tap **My Pump**.
3. Tap **Personal Profiles**.
4. Tap **Pump Settings**.

5. Tap Max Bolus.



Using the on-screen keypad, enter the desired amount for maximum bolus (1–25 units) and tap .

NOTE

If you set the max bolus to 25 units and a bolus larger than 25 units is calculated using your carb ratio or correction factor, after the bolus is delivered a reminder screen will appear. The option of delivering the remaining amount of the bolus up to an additional 25 units will be given (see [Section 12.9 Max Bolus Alerts](#)).

7.8 Quick Bolus

The Quick Bolus function enables you to deliver a bolus by simply pressing a

button. It is a way to deliver a bolus by following beep/vibration commands without navigating through or viewing the pump screen.

Quick Bolus can be configured to correspond to either units of insulin or grams of carbohydrate. The quick bolus delivery setting (grams of carbohydrate or units of insulin) is independent of the active Personal Profile bolus setting.

Configure Quick Bolus

The default for the Quick Bolus function is off. Quick Bolus can be set to either units of insulin or grams of carbohydrate. The increment options are 0.5, 1.0, 2.0, and 5.0 units; or 2, 5, 10 and 15 grams.

1. From the *Home* screen, tap **OPTIONS**.
2. Tap **My Pump**.
3. Tap **Personal Profiles**.
4. Tap **Pump Settings**.
5. Tap **Quick Bolus**.

6. Tap Increment Type.

7. Tap **units of insulin** or **grams of carbohydrate** to select. Tap .

8. Tap Increment Amount.



9. Select the preferred increment amount.

WARNING

The increment amount is added with each press of the **Screen On/Quick Bolus** button when delivering a quick bolus.

10. Review entered values and tap .

11. Confirm Settings.

- Tap  if entered data is correct.
- Tap  to go back to make changes.

12. Tap the **Tandem logo** to return to the *Home* screen.

Deliver a Quick Bolus

If the Quick Bolus function is turned on, you can deliver a bolus without having to look at the t:slim X2 pump screen. Simply use the **Screen On/Quick Bolus** button to deliver your bolus. Quick boluses are delivered as standard boluses (there is no glucose value entry or extended bolus).

▲ PRECAUTION

ALWAYS look at the screen to confirm correct programming of the bolus amount when you first use the Quick Bolus feature. Looking at the screen will ensure that you are correctly using the beep/vibration commands to program the intended bolus amount.

1. Press and hold the **Screen On/Quick Bolus** button. The *Quick Bolus* screen will appear. Listen for two beeps (if sound volume is set to beep) or feel for vibrations (if sound volume is set to vibrate).
2. Press the **Screen On/Quick Bolus** button for each increment until desired amount is reached. The pump will beep/vibrate for each button press.

3. Wait for the pump to beep/vibrate once for each increment pressed to confirm desired amount.
4. After the pump beeps/vibrates, press and hold the **Screen On/Quick Bolus** button for several seconds to deliver the bolus.

🚩 NOTE

If you want to cancel the bolus and return to the *Home* screen, tap  on the *Quick Bolus* screen.

If more than 10 seconds have passed with no input, the bolus is canceled and never delivered.

You cannot exceed the Max Bolus setting defined in your Pump Settings when using the Quick Bolus feature. Once you reach the Max Bolus amount, a different tone will sound to notify you (if Quick Bolus is set to vibrate, the pump will stop vibrating in response to additional button presses to notify you). Look at the screen to confirm the bolus amount.

You cannot exceed 20 button presses when using the Quick Bolus feature. Once you reach 20 button presses, a different tone will sound to notify you (if Quick Bolus is set to vibrate, the pump will stop vibrating in response to additional button presses to notify you). Look at the screen to confirm the bolus amount.

If you hear a different tone at any point during programming or the pump stops vibrating in response to button presses, look at the screen to confirm the bolus amount. If the *Quick Bolus* screen does not display the correct bolus amount, use the touchscreen to enter bolus information.

- ✓ The *BOLUS INITIATED* screen is temporarily displayed.

🚩 NOTE

If Basal-IQ technology is on and has suspended insulin delivery during a Quick Bolus, the remaining Quick Bolus insulin will be delivered.

7.9 Canceling or Stopping a Bolus

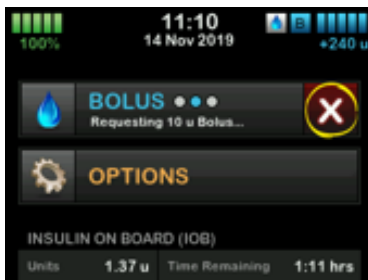

Canceling a Bolus If delivery HAS NOT STARTED:

1. Tap 1–2–3 to access the *Home* screen.
2. Tap  to cancel the bolus.



- ✓ BOLUS will remain inactive while the bolus is being canceled.
- ✓ Once canceled, BOLUS will become active again on the *Home* screen.

Stopping a Bolus if delivery of the BOLUS HAS STARTED:

1. Tap 1–2–3 to access the *Home* screen.
2. Tap  to stop delivery.
3. Tap .
 - ✓ The *BOLUS STOPPED* screen is displayed and the units delivered are calculated.
 - ✓ Units requested and delivered are shown.
4. Tap .

This Page is Intentionally Left Blank

2 t:slim X2 Insulin Pump Features

CHAPTER 8

Start, Stop, or Resume Insulin

8.1 Starting Insulin Delivery

Insulin delivery starts once you have a Personal Profile configured and activated. See [Chapter 6 Personal Profiles](#) for instructions on creating, configuring, and activating a Personal Profile.

8.2 Stopping Insulin Delivery

You can stop all insulin delivery at any time. When you stop all insulin delivery, any active bolus and any active temp rate are immediately stopped. No insulin delivery can take place while your pump is stopped.

1. From the *Home* screen, tap **OPTIONS**.
 2. Tap **STOP INSULIN**.
 3. Tap .
- ✓ The *All Deliveries Stopped* screen appears before returning to the *Home* screen showing the status **ALL DELIVERIES STOPPED**. A red

exclamation mark icon also appears to the right of the time and date.

NOTE

If you manually stop insulin delivery, you must manually resume insulin delivery. Basal-IQ™ technology does not automatically resume insulin if you decide to stop it manually.

8.3 Resuming Insulin Delivery

If pump screen is not on, press **Screen On/Quick Bolus** button once to turn on your t:slim X2 pump screen.

1. Tap **1–2–3**.
 2. Tap .
- ✓ The *RESUMING INSULIN* screen is temporarily displayed.

– OR –

1. From the *Home* screen, tap **OPTIONS**.
2. Tap **RESUME INSULIN**.
3. Tap **RESUME**.

- ✓ The *RESUMING INSULIN* screen is temporarily displayed.

2 t:slim X2 Insulin Pump Features

CHAPTER 9

t:slim X2 Insulin Pump Information and History

9.1 t:slim X2 Pump Info

Your pump allows access to information about your pump. In the *Pump Info* screen you have access to items such as your pump Serial Number, Customer Technical Support contact information, website, and software/hardware versions.

1. From the *Home* screen, tap **OPTIONS**.
2. Tap **My Pump**.
3. Tap **Pump Info**.
4. Scroll through the Pump Info using the **Up/Down Arrows**.
5. Tap **Tandem logo** to return to the *Home* screen.

9.2 t:slim X2 Pump History

Pump History displays a historical log of pump events. At least 90 days of data can be viewed in History. When the maximum number of events is reached,

the oldest events are removed from the history log and replaced with the most recent events. The following can be viewed in History:

Delivery Summary, Total Daily Dose, Bolus, Basal, Load, BG, Alerts and Alarms, Basal-IQ, and Complete.

Delivery Summary breaks down total insulin delivery by basal and bolus types into units and percentages. It can be viewed by the selected time period of: Today, 7 Day, 14 Day and 30 Day Average.

Total Daily Dose breaks down basal and bolus delivery into units and percentages for each individual day. You can scroll through each individual day to see your total insulin delivery.

The Bolus, Basal, Load, BG, Alerts and Alarms, and Complete are categorized by date. The event details in each report are listed by time.

The letter “D” (D: Alert) before an Alert or Alarm indicates the time it was declared. The letter “C” (C: Alert) indicates the time it was cleared.

Bolus history shows the bolus request, the bolus start time, and the bolus completion time.

The Basal-IQ history shows the historical log of the Basal-IQ™ technology status, including when the feature is enabled or disabled, as well as the time(s) that insulin was suspended and resumed.

1. From the *Home* screen, tap **OPTIONS**.
2. Tap the **Down Arrow**.
3. Tap **History**.
4. Tap **Pump History**.
5. Tap desired option.
6. Tap **Tandem logo** to return to the *Home* screen.

2 t:slim X2 Insulin Pump Features

CHAPTER 10

t:slim X2 Insulin Pump Reminders

Your pump lets you know important information about the System with Reminders, Alerts, and Alarms. Reminders are displayed to notify you of an option that you have set (for example, a reminder to check you BG after a bolus). Alerts display automatically to notify you about safety conditions that you need to know (for example, an alert that your insulin level is low). Alarms display automatically to let you know of an actual or potential stopping of insulin delivery (for example, an alarm that the insulin cartridge is empty). Pay special attention to Alarms.

If multiple Reminders, Alerts, and Alarms happen at the same time, Alarms will be displayed first, Alerts will be displayed second, and Reminders will be displayed third. Each must be confirmed separately until all have been acknowledged.

Information in this section will help you learn how to respond to Reminders.

Reminders notify you with a single sequence of 3 notes or a single vibration depending on the volume/vibrate setting in Sound Volume. They repeat every 10 minutes



until acknowledged. Reminders do not escalate.

10.1 Low BG Reminder

The Low BG Reminder prompts you to re-test your BG after a low glucose value is entered. When turning this reminder on, you need to set a low glucose value that triggers the reminder, as well as how much time should pass before the reminder occurs.

The default for this reminder is preset to off. If on, the defaults are Remind Me Below 70 mg/dL, and Remind Me After 15 min, but you can set these values from 70 to 120 mg/dL and 10 to 20 min.

1. From the *Home* screen, tap **OPTIONS**.
2. Tap **My Pump**.
3. Tap **Alerts & Reminders**.
4. Tap **Pump Reminders**.
5. Tap **Low BG**.

6. Low BG is set to on; to turn off, tap **Low BG**.
 - a. Tap **Remind Me Below** and using the on-screen keypad, enter a Low BG value (from 70 to 120 mg/dL) that you want to trigger the reminder, then tap .
 - b. Tap **Remind Me After** and using the on-screen keypad, enter the time (from 10 to 20 min), then tap .
 - c. Tap  when all changes are complete.
 - d. Tap **Tandem logo** to return to the *Home* screen.

To Respond to the Low BG Reminder

To clear the reminder, tap  and then check your BG.

10.2 High BG Reminder



The High BG Reminder prompts you to re-test your BG after a high glucose value is entered. When you turn this reminder on, you need to set a high

glucose value that triggers the reminder, as well as how much time should pass before the reminder occurs.

The default for this reminder is preset to off. If on, the defaults are Remind Me Above 200 mg/dL, and Remind Me After 120 min, but you can set these values from 150 to 300 mg/dL and 1 to 3 hrs.

1. From the *Home* screen, tap **OPTIONS**.
2. Tap **My Pump**.
3. Tap **Alerts & Reminders**.
4. Tap **Pump Reminders**.
5. Tap **High BG**.
6. High BG is set to on; to turn off, tap **High BG**.
 - a. Tap **Remind Me Above** and using the on-screen keypad, enter a High BG value (from 150 to 300 mg/dL) that you want to

trigger the reminder, then tap .

- b. Tap **Remind Me After** and using the on-screen keypad, enter the time (from 1 to 3 hours), then tap .
- c. Tap  when all changes are complete.

7. Tap **Tandem logo** to return to the *Home* screen.



To Respond to the High BG Reminder

To clear the reminder tap  and then check your BG.

10.3 After Bolus BG Reminder

The After Bolus BG Reminder prompts you to test your BG at a selected time after bolus delivery. When turning this reminder on, you need to set how much time should pass before the reminder occurs. The default is 1 hour and 30 minutes. It can be set from 1 to 3 hours.

1. From the *Home* screen, tap **OPTIONS**.

2. Tap **My Pump**.
3. Tap **Alerts & Reminders**.
4. Tap **Pump Reminders**.
5. Tap **After Bolus BG**.
6. After Bolus BG is set to on; to turn off, tap **After Bolus BG**.
7. Tap **Remind Me After** and using the on-screen keypad, enter the time (from 1 to 3 hours) that you want to trigger the reminder, then tap .
8. Tap  when all changes are complete.
9. Tap **Tandem logo** to return to the *Home* screen.







To Respond to the After Bolus BG Reminder

To clear the reminder tap  and then check BG using your BG meter.

10.4 Missed Meal Bolus Reminder

The Missed Meal Bolus Reminder lets you know if a bolus was not delivered during a specified time period. Four separate reminders are available. When programming this reminder you need to select the Days, the Start Time, and End Time for each reminder.

1. From the *Home* screen, tap **OPTIONS**.
2. Tap **My Pump**.
3. Tap **Alerts & Reminders**.
4. Tap **Pump Reminders**.
5. Tap **Missed Meal Bolus**.
6. On the Missed Meal Bolus screen, tap which reminder you want to set (Reminder 1 to 4) and do the following:
 - a. Tap **Reminder 1** (or 2, 3, 4).
 - b. Reminder 1 is set to on; to turn off, tap **Reminder 1**.

- c. Tap **Selected Days** and tap the day(s) you want the reminder to be on, then tap .
 - d. Tap **Start Time**, tap **Time** and using the on-screen keypad enter the start time, then tap .
 - e. Tap **Time of Day** to select AM or PM, if applicable, then tap .
 - f. Tap **End Time**, tap **Time** and using the on-screen keypad enter the end time, then tap .
 - g. Tap **Time of Day** to select AM or PM, if applicable, then tap .
 - h. Tap  when all changes are complete.
7. Tap the **Tandem** logo to return to the *Home* screen.

To Respond to the Missed Meal Bolus Reminder

To clear the reminder tap  and deliver a bolus if necessary.

10.5 Site Reminder

The Site Reminder prompts you to change your infusion set. The default for this reminder is preset to off. If on, the reminder can be set for 1 – 3 days and at a time of day selected by you.

For detailed information on the Site Reminder feature, see [Section 5.6 Setting Site Reminder](#).

To Respond to the Site Reminder

To clear the reminder tap  and change your infusion set.

2 t:slim X2 Insulin Pump Features

CHAPTER 11

User Settable Alerts and Alarms

11.1 Low Insulin Alert

Your t:slim X2™ pump keeps track of how much insulin remains in the cartridge and alerts you when it is low. The default for this alert is preset to 20 units. You can set this alert setting anywhere between 10 and 40 units. When the insulin amount reaches the set value, the Low Insulin Alert beeps/vibrates and appears on the screen. After the alert is cleared, the low insulin indicator (a single red bar on the insulin level display on the *Home* screen appears).

1. From the *Home* screen, tap **OPTIONS**.
2. Tap **My Pump**.
3. Tap **Alerts & Reminders**.
4. Tap **Pump Alerts**.
5. Tap **Low Insulin**.
6. Using the on-screen keypad, enter the number of units (from 10 to 40 units) that you want the Low Insulin

Alert value to be set to, and tap



7. Tap  when all changes are complete.

To Respond to the Low Insulin Alert

To clear the alert, tap .

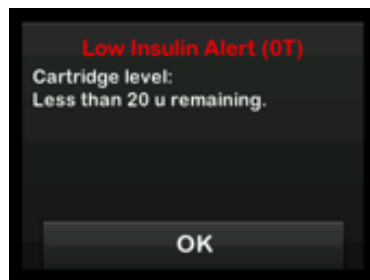





11.2 Auto-Off Alarm

Your pump can stop insulin delivery and alert you (or whoever is with you) if there has been no interaction with the pump within a specified period of time. The default for this alarm is preset to 12 hours. You can set it anywhere between 5 and 24 hours, or off. This alarm notifies you that there has been

no interaction with the pump in the specified number of hours and the pump will shut down after 60 seconds.

When the number of hours since you have pressed the **Screen On/Quick Bolus** button and tapped any interactive screen option or delivered a Quick Bolus passes the set value, the Auto-Off Alarm beeps and appears on the screen, and insulin delivery stops.

1. From the *Home* screen, tap **OPTIONS**.
2. Tap **My Pump**.
3. Tap **Alerts & Reminders**.
4. Tap **Pump Alerts**.
5. Tap **Auto-Off**.
6. Tap **Auto-Off**. A confirmation screen will appear.
 - Tap  to continue.
 - Tap  to go back.
7. Verify Auto-Off is set to on, then tap **Time**.

8. Using the on-screen keypad, enter the number of hours (from 5 – 24 hours) that you want the Auto-Off Alarm to be triggered, and tap .
9. Tap , then tap  when all changes are complete.
10. Tap **Tandem logo** to return to the *Home* screen.

To Respond to Auto-Off Warning

Tap **DO NOT SHUT DOWN**.

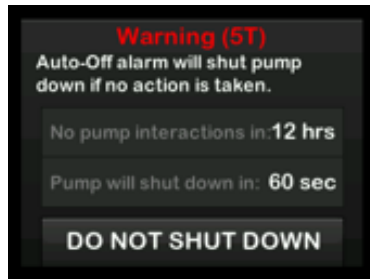

- ✓ The warning clears and the pump returns to normal operation.

If you do not clear the warning within the 60-second countdown period, the

AUTO-OFF ALARM occurs, accompanied by an audible alarm. This alarm notifies you that your pump has stopped delivering insulin.

Auto-Off Alarm Screen

Tap .

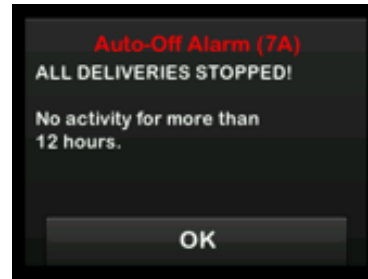

- ✓ The *Home* screen appears, indicating a status of All Deliveries Stopped.

You must resume delivery to continue therapy, see [Section 8.3 Resuming Insulin Delivery](#).

11.3 Max Basal Alert

Your pump allows you to set a limit to the basal rate that the pump will not allow you to exceed during a Temp Rate.

Once the Basal Limit in the Pump Settings has been set up (see [Section 4.10 Basal Limit](#)), you will receive an alert if the following scenarios occur.

1. A Temp Rate was requested that exceeds the Basal Limit.
2. A Temp Rate is in progress, and a new Personal Profile time segment has begun, causing the Temp Rate to exceed the Basal Limit.

To Respond to Max Basal Alert

Tap  to accept the reduced Temp Rate. The reduced Temp Rate value is

the same Basal Limit value that was set up in Personal Profiles.

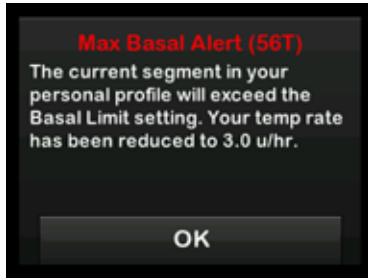

2 t:slim X2 Insulin Pump Features

CHAPTER 12

t:slim X2 Insulin Pump Alerts

Your pump lets you know important information about the System with Reminders, Alerts, and Alarms. Reminders are displayed to notify you of an option that you have set (for example, a reminder to check you BG after a bolus). Alerts display automatically to notify you about safety conditions that you need to know (for example, an alert that your insulin level is low). Alarms display automatically to let you know of an actual or potential stopping of insulin delivery (for example, an alarm that the insulin cartridge is empty). Pay special attention to Alarms.

If multiple Reminders, Alerts, and Alarms happen at the same time, Alarms will be displayed first, Alerts will be displayed second, and Reminders will be displayed third. Each must be confirmed separately until all have been confirmed.

Information in this section will help you learn how to respond to Alerts.

Alerts notify you with 2 sequences of 3 notes or 2 vibrations depending on the volume/vibrate setting selected in Sound Volume. They repeat regularly

until acknowledged. Alerts do not escalate.

NOTE

There is an additional list of alerts and errors related to CGM use in [Chapter 25 CGM Alerts and Errors](#).

NOTE

There is an additional list of alerts related to Basal-IQ™ technology use in [Chapter 31 Basal-IQ Technology Alerts](#).

12.1 Low Insulin Alert

What will I see on the screen?

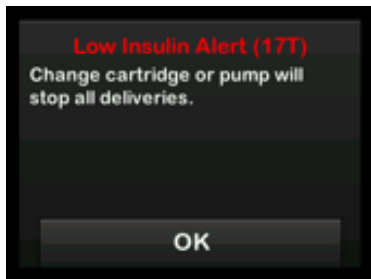

What does it mean?

5 units or less of insulin remain in the cartridge.

How will the System notify me?

2 sequences of 3 notes or 2 vibrations depending on the volume/vibrate setting selected in Sound Volume.

Will the System re-notify me?



Yes, every 5 minutes until acknowledged.

How should I respond?

Tap **OK**. Change your cartridge as soon as possible to avoid the EMPTY CARTRIDGE ALARM and running out of insulin.

12.2 Low Power Alerts

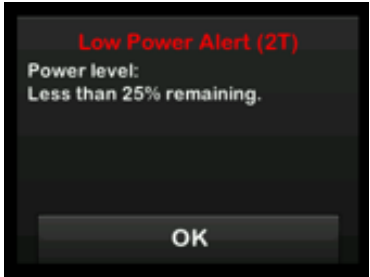
Low Power Alert 1

<p>What will I see on the screen?</p> 	<p>What does it mean?</p> <p>Less than 25% of battery power remains.</p> <hr/> <p>How will the System notify me?</p> <p>2 sequences of 3 notes or 2 vibrations depending on the volume/vibrate setting selected in Sound Volume.</p> <hr/> <p>Will the System re-notify me?</p> <p>Yes, every 5 minutes until acknowledged.</p> <hr/> <p>How should I respond?</p> <p>Tap . Charge your pump as soon as possible to avoid the second LOW POWER ALERT.</p>
--	--

NOTE

Once the LOW POWER ALERT occurs, the low-power indicator (a single red bar on the battery level display on the *Home* and *Lock* screens) appears.

Low Power Alert 2

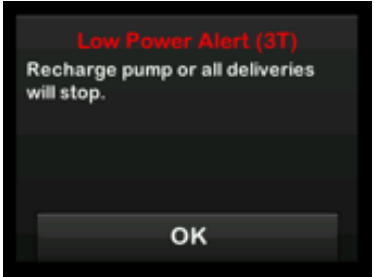
<p>What will I see on the screen?</p> 	<p>What does it mean?</p> <p>Less than 5% of battery power remains. Insulin delivery will continue for 30 minutes and then the pump will power off and insulin delivery will stop.</p> <p>How will the System notify me?</p> <p>2 sequences of 3 notes or 2 vibrations depending on the volume/vibrate setting selected in Sound Volume.</p> <p>Will the System re-notify me?</p> <p>Yes, every 5 minutes until acknowledged.</p> <p>How should I respond?</p> <p>Tap OK. Charge your pump immediately to avoid the LOW POWER ALARM and system power off.</p>
--	--

NOTE

Once the LOW POWER ALERT occurs, the low-power indicator (a single red bar on the battery level display on the *Home* and *Lock* screens) appears.

12.3 Incomplete Bolus Alert

What will I see on the screen?

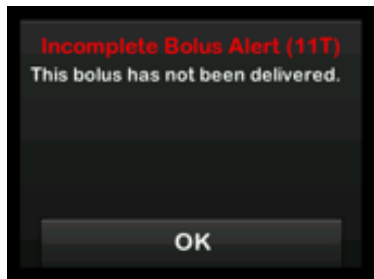

What does it mean?

You started a bolus request but did not complete the request within 90 seconds.



How will the System notify me?

2 sequences of 3 notes or 2 vibrations depending on the volume/vibrate setting selected in Sound Volume.



Will the System re-notify me?

Yes, every 5 minutes until acknowledged.

How should I respond?

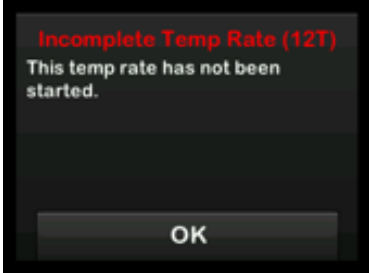

1. Tap . The *Bolus* screen will appear. Continue with your bolus request.
2. Tap  if you do not want to continue your bolus request.

12.4 Incomplete Temp Rate Alert

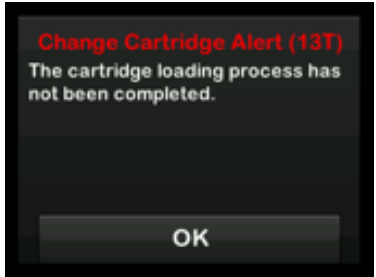

<p>What will I see on the screen?</p> 	<p>What does it mean?</p> <p>You started to set up a temp rate but did not complete the request within 90 seconds.</p> <p>How will the System notify me?</p> <p>2 sequences of 3 notes or 2 vibrations depending on the volume/vibrate setting selected in Sound Volume.</p> <p>Will the System re-notify me?</p> <p>Yes, every 5 minutes until acknowledged.</p> <p>How should I respond?</p> <ol style="list-style-type: none"> 1. Tap . The <i>Temp Rate</i> screen will appear. Continue setting up your temp rate. 2. Tap  if you do not want to continue setting up your temp rate.
--	---

12.5 Incomplete Load Sequence Alerts

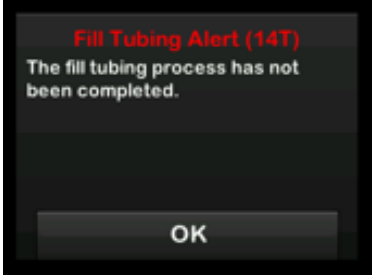

Incomplete Cartridge Change Alert

<p>What will I see on the screen?</p> 	<p>What does it mean?</p> <p>You selected <i>Change Cartridge</i> from the <i>Load</i> menu but did not complete the process within 3 minutes.</p> <hr/> <p>How will the System notify me?</p> <p>2 sequences of 3 notes or 2 vibrations depending on the volume/vibrate setting selected in Sound Volume.</p> <hr/> <p>Will the System re-notify me?</p> <p>Yes, every 5 minutes until acknowledged.</p> <hr/> <p>How should I respond?</p> <p>Tap . Complete the cartridge change process.</p>
--	---

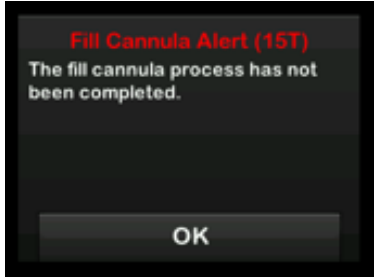

Incomplete Fill Tubing Alert

<p>What will I see on the Screen?</p> 	<p>What does it mean?</p> <p>You selected Fill Tubing from the <i>Load</i> menu but did not complete the process within 3 minutes.</p> <p>How will the System notify me?</p> <p>2 sequences of 3 notes or 2 vibrations depending on the volume/vibrate setting selected in Sound Volume.</p> <p>Will the System re-notify me?</p> <p>Yes, every 5 minutes until acknowledged.</p> <p>How should I respond?</p> <p>Tap . Complete the fill tubing process.</p>
--	--

Incomplete Fill Cannula Alert

<p>What will I see on the Screen?</p> 	<p>What does it mean?</p> <p>You selected <i>Fill Cannula</i> from the <i>Load</i> menu but did not complete the process within 3 minutes.</p> <p>How will the System notify me?</p> <p>2 sequences of 3 notes or 2 vibrations depending on the volume/vibrate setting selected in Sound Volume.</p> <p>Will the System re-notify me?</p> <p>Yes, every 5 minutes until acknowledged.</p> <p>How should I respond?</p> <p>Tap . Complete the cannula fill process.</p>
--	---

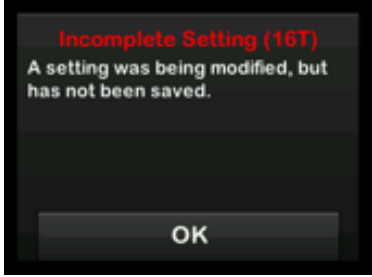
12.6 Incomplete Setting Alert

<p>What will I see on the screen?</p> 	<p>What does it mean?</p> <p>You started to set up a new Personal Profile but did not save or complete the programming within 5 minutes.</p> <p>How will the System notify me?</p> <p>2 sequences of 3 notes or 2 vibrations depending on the volume/vibrate setting selected in Sound Volume.</p> <p>Will the System re-notify me?</p> <p>Yes, every 5 minutes until acknowledged.</p> <p>How should I respond?</p> <p>Tap . Complete programming the Personal Profile.</p>
--	---

12.7 Basal Rate Required Alert

What will I see on the screen?

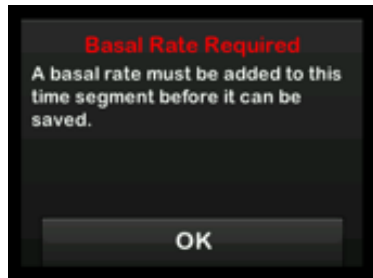

What does it mean?

You did not enter a basal rate in a time segment in Personal Profiles. A basal rate must be entered in each time segment (rate can be 0 u/hr).

How will the System notify me?

Prompt screen only.





Will the System re-notify me?

No, a basal rate must be entered to save the time segment.

How should I respond?

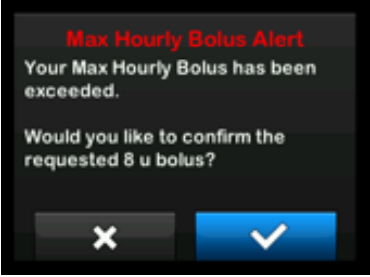



Tap **OK**. Enter a basal rate in the time segment.

12.8 Max Hourly Bolus Alert

<p>What will I see on the screen?</p> 	<p>What does it mean?</p> <p>In the previous 60 minutes, you requested total bolus delivery that is more than 1.5 times your Max Bolus setting.</p> <p>How will the System notify me?</p> <p>Prompt screen only.</p> <p>Will the System re-notify me?</p> <p>No, you must tap  or  to deliver the bolus.</p> <p>How should I respond?</p> <ul style="list-style-type: none"> • Tap  to return to the <i>Bolus</i> screen and adjust the bolus delivery amount. • Tap  to confirm the bolus.
--	---

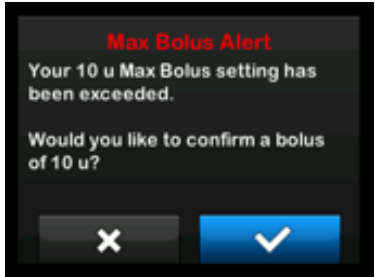
12.9 Max Bolus Alerts

Max Bolus Alert 1

<p>What will I see on the screen?</p> 	<p>What does it mean?</p> <p>You requested a bolus larger than the Max Bolus setting in your active Personal Profile.</p> <p>How will the System notify me?</p> <p>Prompt screen only.</p> <p>Will the System re-notify me?</p> <p>No, you must tap  or  to deliver the bolus.</p> <p>How should I respond?</p> <ul style="list-style-type: none"> • Tap  to return to the <i>Bolus</i> screen and adjust the bolus delivery amount. • Tap  to deliver the amount of your Max Bolus setting.
--	--

Max Bolus Alert 2

The following applies only if you have Carbs turned on in your active Personal Profile and your Max Bolus amount is set to 25 units.

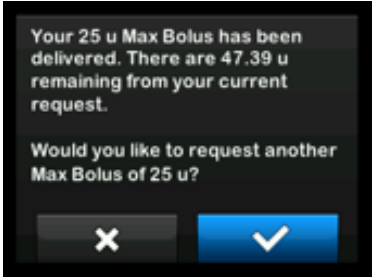
<p>What will I see on the screen?</p> 	<p>What does it mean?</p> <p>Your Max Bolus is set to 25 units and you requested a bolus larger than 25 units.</p> <hr/> <p>How will the System notify me?</p> <p>Prompt screen only.</p> <hr/> <p>Will the System re-notify me?</p> <p>No, you must tap <input type="checkbox"/> or <input checked="" type="checkbox"/> to deliver the remaining amount of the bolus request.</p> <hr/> <p>How should I respond?</p> <p>Before responding to this Alert, always consider whether your bolus insulin needs have changed since you requested the original bolus.</p> <ul style="list-style-type: none"> • Tap <input checked="" type="checkbox"/> to deliver the remaining amount of the bolus request. A confirmation screen will appear. • Tap <input type="checkbox"/> if you do not want to deliver the remaining amount of the bolus request.
--	---

12.10 Max Basal Alert

What will I see on the screen?

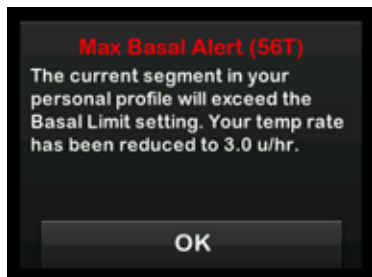

What does it mean?

An active Temp Rate exceeds your Basal Limit setting due to a new timed segment activation within Personal Profiles. This alert will only display once your timed setting segment changes.

How will the System notify me?

2 sequences of 3 notes or 2 vibrations depending on the volume/vibrate setting selected in Sound Volume.

Will the System re-notify me?





No, you must tap **OK** to move forward.

How should I respond?

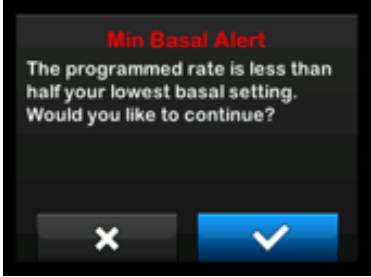

Tap **OK** to accept the reduced Temp Rate. The reduced Temp Rate value is the same as the Basal Limit value that was set up in Personal Profiles.

12.11 Min Basal Alerts



Min Basal Alert 1

<p>What will I see on the screen?</p> 	<p>What does it mean?</p> <p>When entering a basal rate or requesting a temp rate, you requested a basal rate less than half of the lowest basal rate defined in your Personal Profile.</p> <hr/> <p>How will the System notify me?</p> <p>Prompt screen only.</p> <hr/> <p>Will the System re-notify me?</p> <p>No, you must tap  or  to move forward.</p> <hr/> <p>How should I respond?</p> <ul style="list-style-type: none"> • Tap  to return to the previous screen to adjust the amount. • Tap  to dismiss the alert and continue with the request.
--	--

Min Basal Alert 2

<p>What will I see on the screen?</p> 	<p>What does it mean?</p> <p>An active temp rate dropped below half of your lowest basal setting defined in your Personal Profile.</p> <hr/> <p>How will the System notify me?</p> <p>2 sequences of 3 notes or 2 vibrations depending on the volume/vibrate setting selected in Sound Volume.</p> <hr/> <p>Will the System re-notify me?</p> <p>Yes, every 5 minutes until acknowledged.</p> <hr/> <p>How should I respond?</p> <p>Tap  and review your current temp rate in the <i>Options</i> menu.</p>
--	---

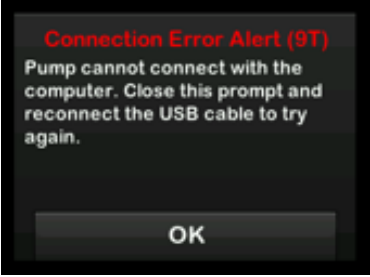
12.12 Connection Error Alert

<p>What will I see on the screen?</p> 	<p>What does it mean?</p> <p>You connected pump to a computer with the USB cable to charge it or upload data to the t:connect web application and a connection could not be made.</p>
	<p>How will the System notify me?</p> <p>2 sequences of 3 notes or 2 vibrations depending on the volume/vibrate setting selected in Sound Volume.</p>
	<p>Will the System re-notify me?</p> <p>Yes, every 5 minutes until acknowledged.</p>
	<p>How should I respond?</p> <p>Tap . Disconnect and reconnect the USB cable to try again.</p>

12.13 Pairing Code Timeout

What will I see on the screen?

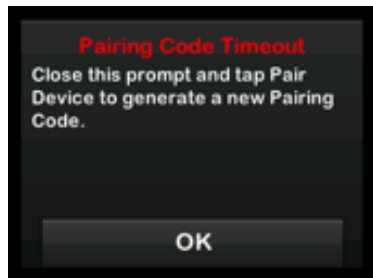

What does it mean?

You attempted to connect a smartphone to the pump, but the pairing process took too long (more than 5 minutes) and was unsuccessful.

How will the System notify me?

2 sequences of 3 notes or 2 vibrations depending on the volume/vibrate setting selected in Sound Volume.



Will the System re-notify me?

No.

How should I respond?

Tap . Try to pair the smartphone again.

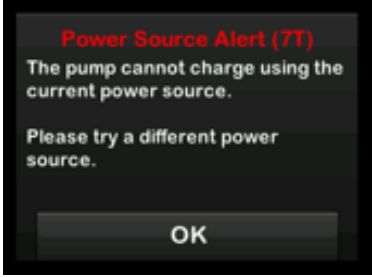
12.14 Power Source Alert

<p>What will I see on the screen?</p> 	<p>What does it mean?</p> <p>You connected your pump to a power source that does not have enough power to charge the pump.</p> <p>How will the System notify me?</p> <p>2 sequences of 3 notes or 2 vibrations depending on the volume/vibrate setting selected in Sound Volume.</p> <p>Will the System re-notify me?</p> <p>Yes, every 5 minutes until acknowledged.</p> <p>How should I respond?</p> <p>Tap . Connect the pump to a different power source to charge.</p>
--	--

12.15 Data Error Alert

What will I see on the screen?

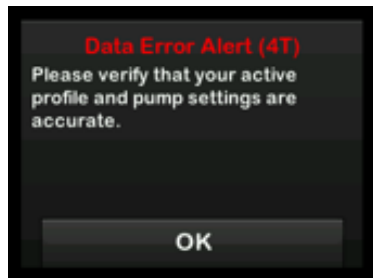

What does it mean?

Your pump encountered a condition that could potentially result in a loss of data.

How will the System notify me?

2 sequences of 3 notes or 2 vibrations depending on the volume/vibrate setting selected in Sound Volume.

Will the System re-notify me?

Yes, every 5 minutes until acknowledged.

How should I respond?

Tap . Check your Personal Profiles and pump settings to verify that they are accurate. See [Section 6.4 Editing or Reviewing an Existing Profile](#).

2 t:slim X2 Insulin Pump Features

CHAPTER 13

t:slim X2 Insulin Pump Alarms

▲ PRECAUTION

CHECK your pump regularly for potential alarm conditions that may display. It is important to be aware of conditions that may affect insulin delivery and require your attention so you can respond as soon as possible.

Your pump lets you know important information about the System with Reminders, Alerts, and Alarms. Reminders are displayed to notify you of an option that you have set (for example, a reminder to check you BG after a bolus). Alerts display automatically to notify you about safety conditions that you need to know (for example, an alert that your insulin level is low). Alarms display automatically to let you know of an actual or potential stopping of insulin delivery (for example, an alarm that the insulin cartridge is empty). Pay special attention to Alarms.

If multiple Reminders, Alerts, and Alarms happen at the same time, Alarms will be displayed first, Alerts will be displayed second, and Reminders will be displayed third. Each must be confirmed separately until all have been confirmed.

Information in this section will help you learn how to respond to Alarms.

Alarms notify you with 3 sequences of 3 notes or 3 vibrations depending on the volume/vibrate setting selected in Sound Volume. If not acknowledged, alarms escalate to highest volume and vibrate. Alarms repeat regularly until the condition that caused the alarm is corrected.

🚩 NOTE

There is a list of alerts and errors related to CGM use in [Chapter 25 CGM Alerts and Errors](#).

🚩 NOTE

There is a list of alerts related to Basal-IQ™ technology use in [Chapter 31 Basal-IQ Technology Alerts](#).

13.1 Resume Pump Alarm

What will I see on the screen?

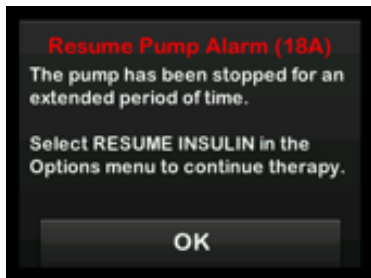

What does it mean?



You selected STOP INSULIN in the *Options* menu and insulin delivery has been stopped for more than 15 minutes.

How will the System notify me?

3 sequences of 3 notes or 3 vibrations depending on the volume/vibrate setting selected in Sound Volume.

Will the System re-notify me?

Yes.

- If not acknowledged by tapping , the System will re-notify you every 3 minutes at highest volume and vibrate.
- If acknowledged by tapping , the System will re-notify you in 15 minutes.

How should I respond?

To resume insulin, from the *Options* menu, tap RESUME INSULIN and tap RESUME to confirm.

13.2 Low Power Alarm

What will I see on the screen?

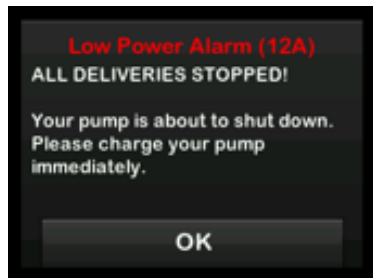

What does it mean?

Your pump detected a power level of 1% or less remaining and all deliveries have stopped.

How will the System notify me?

3 sequences of 3 notes or 3 vibrations depending on the volume/vibrate setting selected in Sound Volume.

Will the System re-notify me?

Yes, every 3 minutes until no power remains and the pump shuts down.

How should I respond?

Tap . Charge your pump immediately to resume insulin delivery.

13.3 Empty Cartridge Alarm

<p>What will I see on the screen?</p> 	<p>What does it mean?</p> <p>Your pump detected that the cartridge is empty and all deliveries have stopped.</p> <p>How will the System notify me?</p> <p>3 sequences of 3 notes or 3 vibrations depending on the volume/vibrate setting selected in Sound Volume.</p> <p>Will the System re-notify me?</p> <p>Yes, every 3 minutes until you change the cartridge.</p> <p>How should I respond?</p> <p>Tap OK. Change your cartridge immediately by tapping OPTIONS from the <i>Home</i> screen, then Load and follow the instructions in Section 5.3 Filling and Loading a t:slim X2 Cartridge.</p>
--	--

13.4 Cartridge Error Alarm

What will I see on the screen?



What does it mean?

Your pump detected that the cartridge could not be used and all deliveries have stopped. This can be caused by cartridge defect, not following the proper procedure to load the cartridge, or over filling the cartridge (with more than 300 units of insulin).

How will the System notify me?

3 sequences of 3 notes or 3 vibrations depending on the volume/vibrate setting selected in Sound Volume.

Will the System re-notify me?

Yes, every 3 minutes until you change the cartridge.

How should I respond?

Tap . Change your cartridge immediately by tapping **OPTIONS** from the *Home* screen, then **Load** and follow the instructions in [Section 5.3 Filling and Loading a t:slim X2 Cartridge](#).

13.5 Cartridge Removal Alarm

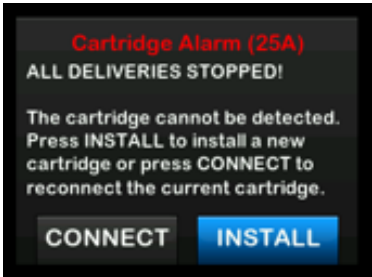
<p>What will I see on the screen?</p> 	<p>What does it mean?</p> <p>Your pump detected that the cartridge has been removed and all deliveries have stopped.</p> <p>How will the System notify me?</p> <p>3 sequences of 3 notes or 3 vibrations depending on the volume/vibrate setting selected in Sound Volume.</p> <p>Will the System re-notify me?</p> <p>Yes, every 3 minutes until you reconnect the current cartridge or change the cartridge.</p> <p>How should I respond?</p> <p>Tap CONNECT to reattach the current cartridge. Tap INSTALL to load a new cartridge.</p>
--	--

13.6 Temperature Alarm

What will I see on the screen?



What does it mean?

Your pump detected an internal temperature below 35°F (2°C) or above 113°F (45°C) or a battery temperature below 35°F (2°C) or above 125°F (52°C) and all deliveries have stopped.

How will the System notify me?

3 sequences of 3 notes or 3 vibrations depending on the volume/vibrate setting selected in Sound Volume.

Will the System re-notify me?

Yes, every 3 minutes until a temperature in the operating range is detected.

How should I respond?

Tap . Remove the pump from the extreme temperature and then resume insulin delivery.

13.7 Occlusion Alarm 1

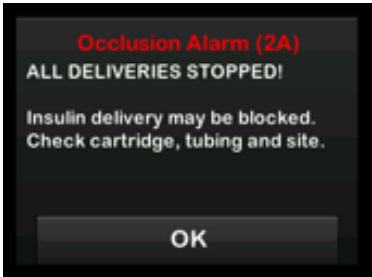
<p>What will I see on the screen?</p> 	<p>What does it mean?</p> <p>Your pump detected that insulin delivery is blocked and all deliveries have stopped. See Section 33.4 t:slim X2 Pump Performance Characteristics for more information on how long it can take the system to detect an occlusion.</p> <p>How will the System notify me?</p> <p>3 sequences of 3 notes or 3 vibrations depending on the volume/vibrate setting selected in Sound Volume.</p> <p>Will the System re-notify me?</p> <p>Yes, every 3 minutes until you resume insulin delivery.</p> <p>How should I respond?</p> <p>Tap OK. Check the cartridge, tubing, and infusion site for any sign of damage or blockage and correct the condition. To resume insulin, from the <i>Options</i> menu, tap RESUME INSULIN and tap RESUME to confirm.</p>
--	--

NOTE

If the occlusion alarm occurs during bolus delivery, after tapping **OK**, a screen will appear letting you know how much of the requested bolus was delivered before the occlusion alarm. When the occlusion is cleared, some or all of the previously requested insulin volume may be delivered. Test your BG at the time of alarm and follow your healthcare provider's instructions for managing potential or confirmed occlusions.

13.8 Occlusion Alarm 2

What will I see on the screen?

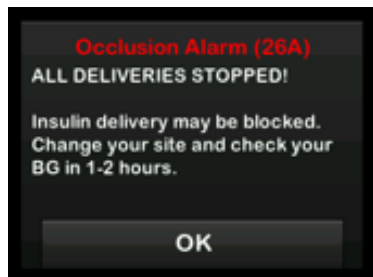

What does it mean?

Your pump detected a second occlusion alarm shortly after the first occlusion alarm and all deliveries have stopped.

How will the System notify me?

3 sequences of 3 notes or 3 vibrations depending on the volume/vibrate setting selected in Sound Volume.

Will the System re-notify me?

Yes, every 3 minutes until you resume insulin delivery.



How should I respond?

Tap **OK**. Change the cartridge, tubing, and infusion site to ensure proper delivery of insulin. Resume insulin after changing the cartridge, tubing, and infusion site.

NOTE

If the second occlusion alarm occurs during bolus delivery, after tapping **OK**, a screen will appear letting you know that the amount of bolus delivery could not be determined and was not added to your IOB.

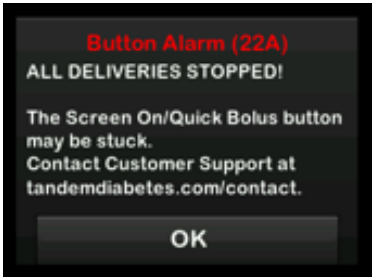
13.9 Screen On/Quick Bolus Button Alarm

<p>What will I see on the screen?</p> 	<p>What does it mean?</p> <p>The Screen On/Quick Bolus button (on the top of your pump) is stuck or not functioning properly and all deliveries have stopped.</p> <p>How will the System notify me?</p> <p>3 sequences of 3 notes or 3 vibrations depending on the volume/vibrate setting selected in Sound Volume.</p> <p>Will the System re-notify me?</p> <p>Yes, every 3 minutes until the condition is corrected.</p> <p>How should I respond?</p> <p>Tap . Contact Customer Technical Support.</p>
--	---

13.10 Altitude Alarm

What will I see on the screen?

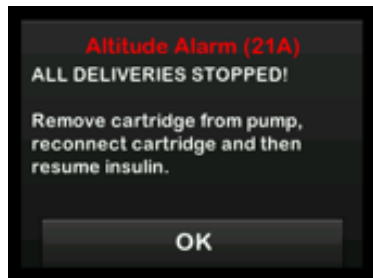

What does it mean?

Your pump detected a pressure difference between inside the cartridge and the surrounding air within the validated operating range of -1,300 feet to 10,000 feet (-396 meters to 3,048 meters) and all deliveries have stopped.

How will the System notify me?

3 sequences of 3 notes or 3 vibrations depending on the volume/vibrate setting selected in Sound Volume.

Will the System re-notify me?

Yes, every 3 minutes until the condition is corrected.

How should I respond?

Tap . Remove the cartridge from the pump (this will allow the cartridge to fully vent) and then reconnect the cartridge.

13.11 Reset Alarm

What will I see on the screen?

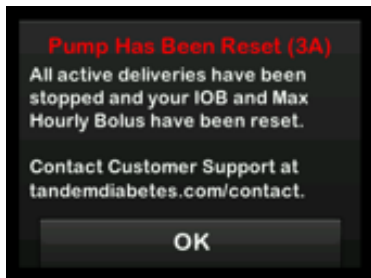

What does it mean?

Your pump detected that one of its micro-processors experienced a reset and all deliveries have been stopped.

How will the System notify me?

3 sequences of 3 notes or 3 vibrations depending on the volume/vibrate setting selected in Sound Volume.

Will the System re-notify me?

Yes, every 3 minutes until you tap **OK**.

How should I respond?

Tap **OK**. Contact Customer Technical Support.

This Page is Intentionally Left Blank

2 t:slim X2 Insulin Pump Features

CHAPTER 14

t:slim X2 Insulin Pump Malfunction

14.1 Malfunction

If your pump detects a system error, the *MALFUNCTION* screen appears and all deliveries are stopped. Contact Customer Technical Support.

Malfunctions notify you with 3 sequences of 3 notes at highest volume and 3 vibrations. They repeat at regular intervals until acknowledged by tapping **SILENCE ALARM**.

▲ PRECAUTION

ALWAYS check with your healthcare provider for specific guidelines if you want or need to disconnect from the pump for any reason. Depending on the length of time and reason you are disconnecting, you may need to replace missed basal and/or bolus insulin. Check your BG before disconnecting from the pump and again when you reconnect, and treat high BG levels as recommended by your healthcare provider.

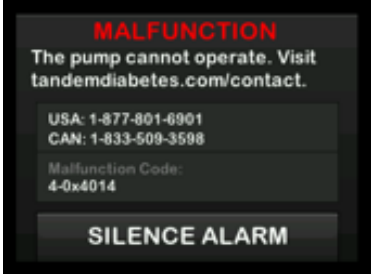
<p>What will I see on the screen?</p> 	<p>What does it mean?</p> <p>Your pump detected a system error and all deliveries have been stopped.</p> <hr/> <p>How will the System notify me?</p> <p>3 sequences of 3 notes at highest volume and 3 vibrations.</p> <hr/> <p>Will the System re-notify me?</p> <p>Yes, every 3 minutes until you acknowledge the malfunction by tapping SILENCE ALARM.</p> <hr/> <p>How should I respond?</p> <ul style="list-style-type: none"> • Write down the Malfunction Code number that appears on the screen. • Tap SILENCE ALARM. The <i>MALFUNCTION</i> screen will remain on the pump even though the alarm is silenced. • Contact Customer Technical Support and provide the Malfunction Code number that you wrote down.
--	---

This Page is Intentionally Left Blank

2 t:slim X2 Insulin Pump Features

CHAPTER 15

Taking Care of Your Pump

15.1 Overview

This section provides information on caring for and maintaining your t:slim X2™ pump.

Cleaning Your Pump

When cleaning your pump, use a damp lint-free cloth. Do not use household or industrial cleaners, solvents, bleach, scouring pads, chemicals, or sharp instruments. Never submerge the pump in water or use any other liquid to clean it. Do not place the pump in the dishwasher or use hot water to clean it. If needed, use only a very mild detergent, such as a bit of liquid soap with warm water. When drying your pump, use a soft towel; never place your pump in a microwave oven or baking oven to dry it.

Wipe the outside of the transmitter with a damp lint-free cloth or isopropyl alcohol wipe between uses.

Maintaining Your Pump

The pump requires no preventative maintenance.

Inspecting Your Pump for Damage

▲ PRECAUTION

DO NOT use your pump if you think it might be damaged due to dropping it or hitting it against a hard surface. Check that the pump is working properly by plugging a power source into the USB port and confirming that the display turns on, you hear audible beeps, feel the pump vibrate, and see the green LED light blinking around the edge of the **Screen On/Quick Bolus** button. If you are unsure about potential damage, discontinue use of the pump and contact Customer Technical Support.

If you drop your pump or it has been hit against something hard, ensure that it is still working properly. Check that the touchscreen is working and clear, and that the cartridge and infusion set are properly in place. Check for leaks around the cartridge and at the tubing connector to the infusion set. Immediately contact Customer Technical Support if you notice any cracks, chips, or other damage.

Storing Your Pump

If you need to stop using your pump for a long period of time, you can place the

pump in storage mode. To place the pump in storage mode, connect the pump to a power source and then press and hold down the **Screen On/Quick Bolus** button for 30 seconds. The pump will beep 3 times before going into storage mode. Disconnect the pump from the power source.

Keep the pump protected when not in use. Store at temperatures between -4°F (-20°C) and 140°F (60°C) and at relative humidity levels between 20% and 90%.

To bring the pump out of storage mode, simply connect the pump to a power source.

Disposing of System Components

Consult your healthcare provider for instructions for disposal of devices containing electronic waste such as your pump and transmitter and for instructions for disposal of potentially biohazardous materials such as used cartridges, needles, syringes, infusion sets, and sensors.

2 t:slim X2 Insulin Pump Features

CHAPTER 16

Lifestyle Issues and Travel

16.1 Overview

While the convenience and flexibility of the pump allow most users to participate in a variety of activities, some lifestyle changes may be required. Additionally, your insulin needs may change in response to lifestyle changes.

▲ PRECAUTION

CONSULT your healthcare provider about lifestyle changes such as weight gain or loss, and starting or stopping exercise. Your insulin needs may change in response to lifestyle changes. Your basal rate(s) and other settings may need adjustment.

Physical Activity

The pump can be worn during most forms of exercise, such as running, cycling, hiking, and resistance training. During exercise, the t:slim X2™ pump can be worn in the provided case, your pocket, or other third-party “sport cases.”

For activities where contact is a concern, such as baseball, hockey, martial arts, or basketball, you can

disconnect from your pump for short periods of time. If planning to disconnect from your pump, discuss a plan with your healthcare provider to compensate for any basal insulin delivery you miss while disconnected, and be sure to continue to check your BG levels. Even if you disconnect your tubing from your infusion site, the pump should continue to receive data from the transmitter as long as it is within the 20-foot (6-meter) range without obstruction.

Aquatic Activities

▲ PRECAUTION

AVOID submerging your pump in fluid beyond a depth of 3 feet (0.91 meters) or for more than 30 minutes (IPX7 rating). If your pump has been exposed to fluid beyond these limits, check for any signs of fluid entry. If there are signs of fluid entry, discontinue use of the pump and contact Customer Technical Support.

Your pump is watertight to a depth of 3 feet (0.91 meters) for up to 30 minutes (IPX7 rating), but it is not waterproof. Your pump should not be worn while swimming, scuba diving, surfing, or during any other activities that could

submerge the pump for an extended period of time. Your pump should not be worn in hot tubs or Jacuzzis.

Extreme Altitudes

Some activities, such as hiking, skiing or snowboarding, could expose your pump to extreme altitudes. The pump has been tested at altitudes up to 10,000 feet (3,048 meters) at standard operating temperatures.

Extreme Temperatures

You should avoid activities which could expose your pump to temperatures below 41°F (5°C) or above 98.6°F (37°C), as insulin can freeze at low temperatures or degrade at high temperatures.

Other Activities Which Require Removing Your Pump

There are other activities, such as bathing and intimacy, when it may be more convenient for you to remove your pump. It is safe to do so for short periods of time. If planning to disconnect from your pump, discuss a plan with your healthcare provider for

compensating for any basal delivery you miss while disconnected, and be sure to check your BG levels frequently. Missing basal delivery could cause your BG to rise.

Travel

The flexibility afforded by an insulin pump can simplify some aspects of travel, but it still requires planning. Be sure to order your pump supplies before your trip so that you have enough supplies with you while you're away from home. In addition to pump supplies, you should also always bring the following items:

- The items listed in the Emergency Kit described in [Section 1.9 Emergency Kit](#).
- A prescription for both rapid-acting and long-acting insulin of the type recommended by your healthcare provider in case you need to take insulin by injection.
- A letter from your healthcare provider explaining the medical need for your insulin pump and other supplies.

Traveling by Air

▲ PRECAUTION

DO NOT expose your pump to X-ray screening used for carry-on and checked luggage. Newer full body scanners used in airport security screening are also a form of X-ray and your pump should not be exposed to them. Notify the security agent that your pump cannot be exposed to X-ray machines and request an alternate means of screening.

Your pump has been designed to withstand common electromagnetic interference including airport metal detectors.

The pump is safe for use on commercial airlines. The pump is a Medical Portable Electronic Device (M-PED). The system complies with radiated emissions requirements defined in RTCA/DO-160G, Section 21, Category M. Any M-PED which meet the requirements of this standard in all modes of operation may be used on board aircraft without the need for further testing by the operator.

Pack your pump supplies in your carry-on luggage. **DO NOT** pack your

supplies in checked luggage as it could get delayed or lost.

If traveling, contact Customer Technical Support prior to your trip to obtain a travel loaner pump in case your pump malfunctions outside Tandem's replacement area.

This Page is Intentionally Left Blank

3 CGM Features

CHAPTER 17

Important CGM Safety Information

The following includes important safety information related to your CGM its components. The information presented in this chapter does not represent all warnings and precautions related to the CGM. Visit the CGM manufacturer's website for applicable user guides that also present warnings and precautions.

17.1 CGM Warnings

Using Dexcom G6 with Your t:slim X2™ Insulin Pump

▲ WARNING

DO NOT ignore symptoms of high and low glucose. If your sensor glucose alerts and readings do not match your symptoms, measure your BG with a BG meter even if your sensor is not reading in the high or low range.

▲ WARNING

DO NOT ignore sensor wire fractures. Sensors may fracture on rare occasions. If a sensor wire breaks and no portion of it is visible above the skin, do not attempt to remove it. Seek professional medical help if you have symptoms of infection or inflammation (redness, swelling, or pain) at the insertion site. If you experience a

broken sensor wire, please report this to Customer Technical Support.

▲ WARNING

DO NOT use Dexcom G6 CGM in pregnant women or persons on dialysis. The System is not approved for use in pregnant women or persons on dialysis and has not been evaluated in these populations. Sensor glucose readings may be inaccurate in these populations and could result in you missing severe hypoglycemia (low BG) or hyperglycemia (high BG) events.

▲ WARNING

DO NOT use Dexcom G6 CGM in critically ill patients. It is not known how different conditions or medications common to the critically ill population may affect the performance of the System. Sensor glucose readings may be inaccurate in critically ill patients, and solely relying on the sensor glucose alerts and readings for treatment decisions could result in you missing severe hypoglycemia (low BG) or hyperglycemia (high BG) events.

▲ WARNING

DO NOT insert the sensor in sites other than the abdomen (belly) or upper buttocks (for ages 6–17 only). Other sites have not been studied and are not approved. Use in other sites might cause

sensor glucose readings to be inaccurate and could result in you missing severe hypoglycemia (low BG) or hyperglycemia (high BG) events.

▲ WARNING

DO NOT expect CGM alerts until after the 2-hour startup. You will NOT get any sensor glucose readings or alerts until after the 2-hour startup ends. During this time you might miss severe hypoglycemia (low BG) or hyperglycemia (high BG) events.

▲ WARNING

DO NOT use your transmitter if it is damaged/cracked. This could create an electrical safety hazard or malfunction, which might cause electrical shocks.

▲ WARNING

STORE the Dexcom G6 CGM sensor at temperatures between 36°F (2.2°C) to 86°F (30°C) for the length of the sensor's shelf life. You may store the sensor in the refrigerator if it is within this temperature range. The sensor should not be stored in a freezer. Storing the sensor improperly might cause the sensor glucose readings to be inaccurate, and you might miss severe hypoglycemia (low BG) or hyperglycemia (high BG) events.

▲ WARNING

DO NOT allow young children to hold the sensor, transmitter or transmitter kit box without adult supervision. The sensor and transmitter include small parts that may pose a choking hazard. Keep the transmitter kit box away from young children; it contains a magnet that should not be swallowed.

17.2 CGM Precautions**Using Dexcom G6 CGM with Your t:slim X2 Insulin Pump****▲ PRECAUTION**

DO NOT open the sensor package until you have washed your hands with soap and water, and let them dry. You may contaminate the insertion site and suffer an infection if you have dirty hands while inserting the sensor.

▲ PRECAUTION

DO NOT insert the sensor until you have cleaned the skin with a topical antimicrobial solution, such as isopropyl alcohol, and allowed the skin to dry. Inserting into unclean skin might lead to infection. Do not insert the sensor until the cleaned area is dry so the sensor adhesive will stick better.

▲ PRECAUTION

AVOID using the same spot repeatedly for sensor insertion. Rotate your sensor placement sites, and do not use the same site for two sensor sessions in a row. Using the same site might cause scarring or skin irritation.

▲ PRECAUTION

AVOID inserting the sensor in areas that are likely to be bumped, pushed or compressed, or areas of skin with scarring, tattoos, or irritation as these are not ideal sites to measure sensor glucose. Insertion in those areas might affect accuracy and could result in you missing severe hypoglycemia (low BG) or hyperglycemia (high BG) events.

▲ PRECAUTION

AVOID injecting insulin or placing an infusion set within 3 inches (7.6 cm) of the sensor. The insulin might affect sensor accuracy and could result in you missing severe hypoglycemia (low BG) or hyperglycemia (high BG) events.

▲ PRECAUTION

DO NOT use the sensor if its sterile package has been damaged or opened. Using an unsterile sensor might cause infection.

▲ PRECAUTION

To calibrate the Dexcom G6 CGM, ALWAYS enter the exact BG value that your BG meter displays within 5 minutes of a carefully performed BG measurement. Do not enter sensor glucose readings for calibration. Entering incorrect BG values, BG values obtained more than 5 minutes before entry, or sensor glucose readings might affect sensor accuracy and could result in you missing severe hypoglycemia (low BG) or hyperglycemia (high BG) events.

▲ PRECAUTION

DO NOT calibrate if your BG is changing at a significant rate, typically more than 2 mg/dL per minute. Do not calibrate when your receiver screen is showing the rising or falling single arrow or double arrow, which indicates that your BG is rapidly rising or falling. Calibrating during significant rise or fall of BG may affect sensor accuracy and could result in you missing severe hypoglycemia (low BG) or hyperglycemia (high BG) events.

▲ PRECAUTION

The Dexcom G5 CGM accuracy may be affected when your glucose is changing at a significant rate (i.e., 2 to 3 mg/dL/min or more than 3 mg/dL each minute), such as during exercise or after a meal.

▲ PRECAUTION

AVOID separating the transmitter and pump by more than 20 feet (6 meters). The transmission range from the transmitter to the pump is up to 20 feet (6 meters) without obstruction. Wireless communication does not work well through water so the range is reduced if you are in a pool, bathtub, or on a water bed, etc. To ensure communication, it is suggested that you face your pump screen out and away from the body, and wear the pump on the same side of the body that you wear your CGM. Types of obstruction differ and have not been tested. If your transmitter and pump are farther than 20 feet (6 meters) apart or are separated by an obstruction, they might not communicate or the communication distance may be shorter and result in you missing severe hypoglycemia (low BG) or hyperglycemia (high BG) events.

▲ PRECAUTION

DO NOT use alternative BG site testing (blood from your palm or forearm, etc.) for calibration. Alternative site BG values may be different than those taken from a fingerstick BG value and may not represent the timeliest BG value. Use a BG value taken only from a fingerstick for calibration. Alternative site BG values might affect sensor accuracy and result in you missing

severe hypoglycemia (low BG) or hyperglycemia (high BG) events.

▲ PRECAUTION

ENSURE that your transmitter ID is programmed into the pump before you use the System if you receive a warranty replacement pump. The pump cannot communicate with the transmitter unless the transmitter ID is entered. If the pump and transmitter are not communicating, you will not receive sensor glucose readings and you might miss severe hypoglycemia (low BG) or hyperglycemia (high BG) events.

▲ PRECAUTION

DO NOT discard your transmitter. It is reusable. The same transmitter is used for each session until you have reached the end of the transmitter battery life.

▲ PRECAUTION

The Dexcom G6 sensor is not compatible with older versions of transmitters or receivers. Do not mix transmitters, receivers, and sensors from different generations.

▲ PRECAUTION

Hydroxyurea is a medication used in the treatment of diseases including cancer and sickle cell anemia. It is known to interfere with

glucose readings from the Dexcom sensor. The use of hydroxyurea will result in sensor glucose readings that are higher than actual glucose levels. The level of inaccuracy in sensor glucose readings is based on the amount of hydroxyurea in the body. Relying on sensor glucose values while taking hydroxyurea could result in missed hypoglycemia alerts or errors in diabetes management, such as giving a higher dose of insulin than necessary to correct falsely high sensor glucose values. It can also result in errors when reviewing, analyzing and interpreting historical patterns for assessing glucose control. **DO NOT** use the Dexcom CGM readings to make diabetes treatment decisions or assess glucose control when taking hydroxyurea.

17.3 Potential Benefits From Using the t:slim X2 System

- When paired with Dexcom G6 transmitter and sensor, your pump can receive CGM readings every 5 minutes, which are displayed as a trend graph on the *Home* screen. You can also program your pump to alert you when your CGM readings are above or below a given level, or are rising or falling quickly.

Unlike the readings from a standard BG meter, CGM readings allow you to view trends in real time, as well as capture information when you would otherwise be unable to check your blood sugar, such as while you are asleep. This information can be useful for you and your healthcare provider when considering changes to your therapy. In addition, the programmable alerts can help you to spot potential low or high BG sooner than you would using a only a BG meter.

- In some studies, CGM was shown to increase time in the target sensor glucose range, without increasing time above or below the target range. Subjects in these studies had better diabetes control (lowered A1C values, reduced glycemic variability and time spent in low and high BG ranges)^{1, 2, 3} which can help reduce diabetes related complications.^{4, 5} These benefits can be seen especially with using real-time CGM at least 6 days per week² and were sustained over time.⁶ In some cases, patients perceived an increase in their quality

of life and peace of mind when using real-time CGM as well as reporting a high satisfaction with CGM.⁷

- ¹ Garg S, Zisser H, Schwartz S, et al. Improvement in glycemic excursions with a transcutaneous, real-time continuous glucose sensor: a randomized controlled trial. *Diabetes Care*. 2006; 29(1):44-50.
- ² JDRF CGM Study Group. Continuous glucose monitoring and intensive treatment of type 1 diabetes. *NEJM*. 2008; 359:1464-76.
- ³ Battelino T, Phillip M, Bratina N, et al. Effect of continuous glucose monitoring of hypoglycemia in type 1 diabetes. *Diabetes Care* 2011; 34(4):795-800.
- ⁴ The Diabetes Control and Complications Research Group. The effect of intensive treatment of diabetes on the development and progression of long- term complications of insulin-dependent diabetes mellitus. *NEJM*. 1993; 329:997-1036.
- ⁵ Ohkubo Y, Kishikawa H, Araki E, et al. Intensive insulin therapy prevents

progression of diabetic microvascular complications in Japanese patients with non-insulin dependent diabetes mellitus: a randomized prospective 6-year study. *Diabetes Res Clin Pract*. 1995; 28(2):103-117.

⁶ JDRF CGM Study Group. Sustained benefit of continuous glucose monitoring on A1c, glucose profiles, and hypoglycemia in adults with type 1 diabetes. *Diabetes Care* 2009; 32(11):2047-2049.

⁷ JDRF CGM Study Group. Quality-of-Life measures in children and adults with type 1 diabetes. *Diabetes Care* 2010; 33(10):2175-2177.

17.4 Possible Risks From Using the t:slim X2 System

Inserting the sensor and wearing the adhesive patch might cause infection, bleeding, pain and skin irritations (readiness, swelling, bruising, itching, scarring, or skin discoloration).

There is a remote chance that a sensor wire fragment could remain under your skin if the sensor wire breaks while you

are wearing it. If you think a sensor wire has broken under your skin, contact your healthcare provider and call Customer Technical Support.

Other risks associated with CGM use include the following:

- You will not get sensor glucose alerts when the alert function is turned off, your transmitter and pump are out of range, or when your pump is not showing sensor glucose readings. You might not notice alerts if you are unable to hear them or feel the vibration.
- There are a number of risks as a result of the fact that the Dexcom G6 CGM takes readings from fluid below the skin (interstitial fluid) instead of blood. There are differences in how glucose is measured in the blood compared to how it is measured in interstitial fluid, and glucose is absorbed into the interstitial fluid slower than it is absorbed into the blood, which can cause CGM readings to lag behind readings from a BG meter.

3 CGM Features

CHAPTER 18

Getting to Know Your CGM System

18.1 CGM Terminology

Alternate Site BG Testing

Alternate site BG testing is when you take a BG value on your meter using a blood sample from an area on your body other than your fingertip. Do not use alternate site testing to calibrate your sensor.

Applicator

The applicator is a disposable piece that comes attached to the sensor pod and inserts the sensor under the skin. There is a needle inside the applicator that is removed after you insert the sensor.

Calibration

Calibration is when you enter BG values from a BG meter into the System. Calibrations may be needed for your System to show continuous glucose readings and trend information.

CGM

Continuous glucose monitoring.

HypoRepeat

HypoRepeat is an optional alert setting that keeps repeating the fixed low alert

every 5 seconds until your sensor glucose value rises above 55 mg/dL or you confirm it. This alert can be helpful if you want extra awareness for severe lows.

mg/dL

Milligrams per deciliter. The standard unit of measure for sensor glucose readings.

Receiver

When the Dexcom G6 CGM is used with the pump to display CGM readings, the insulin pump replaces the receiver for the therapeutic CGM. A smartphone with the Dexcom app may be used in addition to the pump to receive sensor readings.

Rise and Fall (Rate of Change) Alerts

Rise and fall alerts occur based on how much and how fast your sensor glucose levels rise or fall.

RF

RF is the abbreviation for radio frequency. RF transmission is used to send sensor glucose information from the transmitter to the pump.

Sensor

The sensor is the part that includes an applicator and wire. The applicator inserts the wire under your skin, and the wire measures glucose levels in your tissue fluid.

Sensor Glucose Data Gaps

Glucose data gaps occur when your System is unable to provide a sensor glucose reading.

Sensor Glucose Trends

Glucose trends let you see the pattern of your glucose levels. The trend graph shows where your glucose levels have been during the time shown on the screen and where your glucose levels are now.

Sensor Pod

The sensor pod is the small plastic base of the sensor attached to your skin that holds the transmitter in place.

Startup Period

The startup period is the 2-hour period after you tell the System you inserted a new sensor. Sensor glucose readings are not provided during this time.

System Reading

A System reading is a sensor glucose reading shown on your pump. This reading is in mg/dL units and is updated every 5 minutes.

Transmitter

The transmitter is the part of the CGM that snaps into the sensor pod and wirelessly sends sensor glucose information to your pump.

Transmitter ID

The transmitter ID is a series of numbers and/or letters that you enter into your pump to let it connect and communicate with the transmitter.







Trend (Rate of Change) Arrows



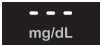



Trend arrows show how fast your sensor glucose levels are changing. There are 7 different arrows that show when your sensor glucose direction and speed change.

18.2 Explanation of CGM Pump Icons

The following CGM icons may appear on your pump screen:

CGM Icon Definitions

Symbol	Meaning
	Unknown sensor reading.
	CGM sensor session is active, but the transmitter is not communicating with the pump.
	The CGM sensor has failed.
	The CGM sensor session has ended.
	Wait 15 minutes calibration error.
	Startup calibration is required (2 BG values).
	Additional startup calibration is required.

Symbol	Meaning
	Transmitter error.
	Sensor startup 0–30 minutes.
	Sensor startup 31–60 minutes.
	Sensor startup 61–90 minutes.
	Sensor startup 91–119 minutes.
	CGM calibration is required.

This Page is Intentionally Left Blank

18.3 CGM Lock Screen

The *CGM Lock* screen appears anytime you turn on the screen and you are using your pump with a CGM.

1. **Time and Date Display:** Displays the current time and date.
2. **Antenna:** Indicates communication status between pump and transmitter.
3. **Battery Level:** Displays the level of battery power remaining. When connected for charging, the charging icon (lightning bolt) will display.
4. **High Glucose Alert Setting.**
5. **Sensor Glucose Target Range.**
6. **Low Glucose Alert Setting.**
7. **Plot of Most Recent Sensor Glucose Readings.**
8. **1–2–3:** Unlocks pump screen.
9. **Active Bolus Icon:** Indicates a bolus is being delivered.
10. **Status:** Displays current system settings and insulin delivery status.
11. **Insulin Level:** Displays the current amount of insulin in the cartridge.
12. **Most Recent 5-Minute Sensor Glucose Reading.**
13. **Trend Arrow:** Indicates direction and rate of change.
14. **Trend Graph Time (HRS):** 1, 3, 6, 12 and 24 hour views available.
15. **Insulin On Board (IOB):** Amount and time remaining of any active insulin on board.

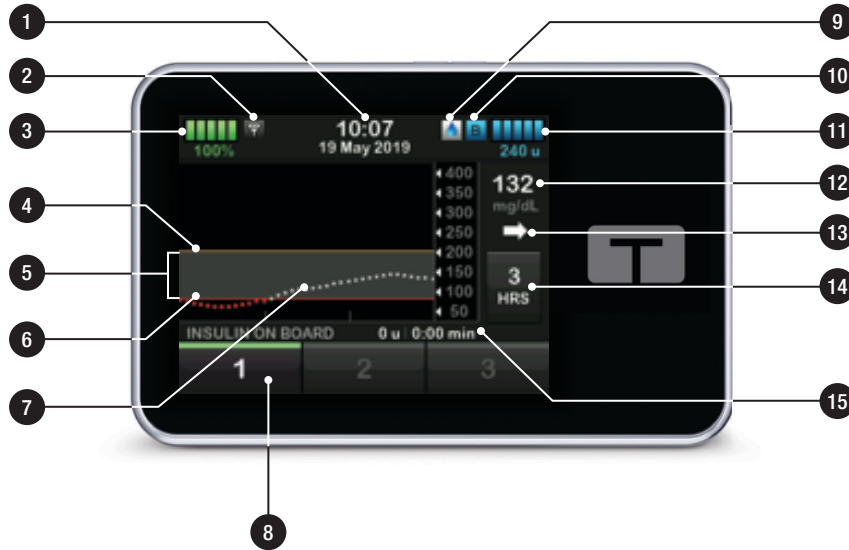

18.4 CGM Home Screen

- Time and Date Display:** Displays the current time and date.
- Antenna:** Indicates communication status between pump and transmitter.
- Battery Level:** Displays the level of battery power remaining. When connected for charging, the charging icon (lightning bolt) will display.
- High Glucose Alert Setting.**
- Sensor Glucose Target Range.**
- Low Glucose Alert Setting.**
- Plot of Most Recent Sensor Glucose Readings.**
- Options:** Stop/Resume insulin delivery, manage pump and CGM settings, program a temp rate, load cartridge, and view history.
- Bolus:** Program and deliver a bolus.
- Status:** Displays current system settings and insulin delivery status.
- Insulin Level:** Displays the current amount of insulin in the cartridge.
- Most Recent 5-Minute Sensor Glucose Reading.**
- Trend Arrow:** Indicates direction and rate of change.
- Trend Graph Time (HRS):** 1, 3, 6, 12 and 24 hour views available.
- Insulin On Board (IOB):** Amount and time remaining of any active insulin on board.

To view CGM information on the full screen:

From the *Home* screen tap anywhere on the CGM trend graph.

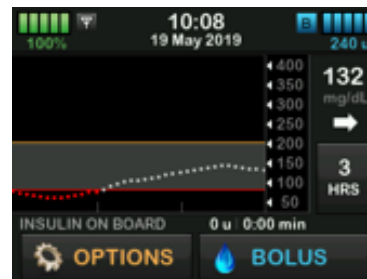

Tap the “minimize” icon to return to the *Home* screen.

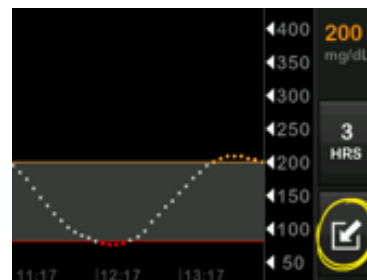

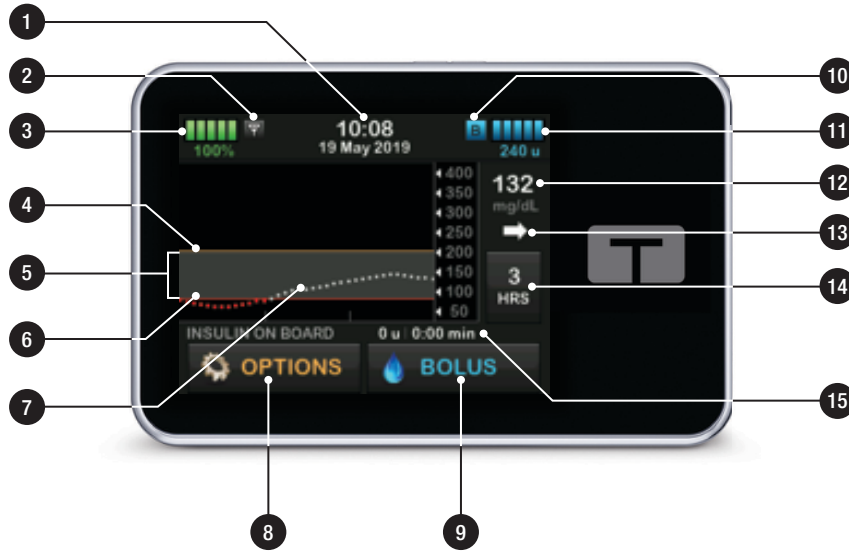

18.5 My CGM Screen

1. **Start Sensor:** Starts a CGM session. If sensor is active, STOP SENSOR will be displayed.
2. **Calibrate CGM:** Enter a calibration BG value. Only active when sensor session is active.
3. **CGM Alerts:** Customize CGM Alerts.
4. **Transmitter ID:** Enter the transmitter ID.
5. **CGM Info:** View the CGM information.

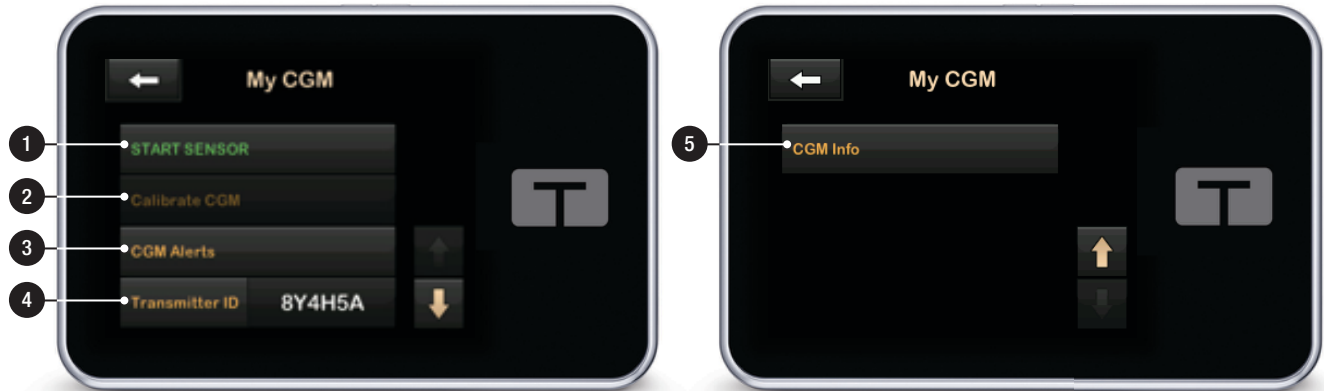

This Page is Intentionally Left Blank

3 CGM Features

CHAPTER 19

CGM Overview

19.1 CGM System Overview

This section of the user guide covers instructions for using a CGM with your t:slim X2™ pump. Use of a CGM is optional, but in order to use Basal-IQ™ technology, CGM is required. When used, CGM allows readings from your sensor to be displayed on your pump screen. To make treatment decisions during a new sensor startup period, you will also need a commercially available BG meter to use with your System.

As an example, a compatible CGM is the Dexcom G6 CGM System, which consists of a sensor, transmitter, and a receiver.

NOTE

The Dexcom G6 CGM only allows pairing with one medical device at a time (either the t:slim X2™ pump or the Dexcom receiver), but you can still use the Dexcom G6 CGM app and your pump simultaneously using the same transmitter ID.

The Dexcom G6 sensor is a disposable device that is inserted under the skin to continuously monitor glucose levels

from interstitial fluid (the fluid under your skin). The Dexcom G6 transmitter connects to the sensor using Bluetooth wireless technology communication and sends readings to the pump display every 5 minutes. The pump display shows sensor glucose readings, a trend graph, and the direction and rate of change arrows. For information about inserting a Dexcom G6 CGM sensor, placing a Dexcom G6 transmitter, and Dexcom G6 product specifications, visit the manufacturer's website for applicable user guides and training information.

You can also program your pump to alert you when your CGM readings are above or below a given level, or are rising or falling quickly. If CGM readings become 55 mg/dL or lower, the Urgent Low Alert will sound. This alert is not customizable.

Unlike the readings from a standard BG meter, CGM readings allow you to view trends in real time, as well as capture information when you would otherwise be unable to check your BG, such as while you are asleep. This information can be useful for you and your

healthcare provider when considering changes to your therapy. In addition, the programmable alerts can help you to spot potential low or high sensor glucose sooner than you would using a only a BG meter.

19.2 Receiver (t:slim X2 Insulin Pump) Overview

To review the icons and controls displayed on the *Home* screen with CGM enabled, see [Section 18.4 CGM Home Screen](#).

19.3 Transmitter Overview

This section provides information about CGM devices that have a separate transmitter. The information contained in this section is specific to the Dexcom G6 CGM and is provided as an example. For information about the Dexcom G6 transmitter, visit the manufacturer's website for applicable user guides.

Snapping into the transmitter holder, the transmitter wirelessly sends sensor glucose information to your pump. If

you have a new transmitter, only open the package when you are ready to use it.

Even if you disconnect your tubing from your infusion site, the pump should continue to receive data from the transmitter as long as it is within the 20-foot (6-meter) range without obstruction.

If your transmitter is damaged or cracked, do not use it. Immediately contact Customer Technical Support if you notice any cracks or other damage. Do not use the sensor if its sterile package has been damaged or opened.

Transmitter features:

- Reusable
 - Do not discard after sensor session.
 - Only for you, don't share a transmitter.
- Water resistant

- Can transmit data to your pump for up to 20 feet (6 meters). Range is less if you are in or under water.
- Battery lasts approximately 90 days. Receiver or smart device prompts you when battery is running low.
- Serial number is on the back
- M-PED designation
 - Emission levels meet IATA standards.
 - May be used on board aircraft without any further testing by the operator.

▲ PRECAUTION

DO keep your transmitter and pump within 20 feet (6 meters) with no obstacles (like walls or metal) between them. Otherwise, they may not be able to communicate. If water is between your transmitter and the pump (for example, if you're showering or swimming) keep them closer to each other. The range is reduced because Bluetooth technology doesn't work as well through water. To ensure communication, it is suggested that you face your pump screen out and away from the body, and wear the pump

on the same side of the body that you wear your CGM.

The transmitter battery will last 90 days. Once you see the Low Transmitter Battery Alert, replace the transmitter as soon as possible. Your transmitter battery may drain as quickly as 7 days after this alert occurs.

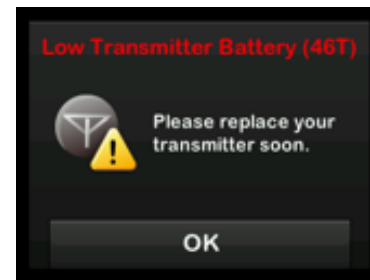

19.4 Sensor Overview

This section provides information about CGM devices that have a separate sensor. The information contained in this section is specific to the Dexcom G6 CGM and is provided as an example. For information about the Dexcom G6 sensor, visit the

manufacturer's website for applicable user guides.

The Dexcom G6 sensor is water resistant when showering, bathing or swimming if the transmitter is fully snapped in. The sensor has been tested to be water resistant when submerged for up to 8 feet (2.4 meters) and up to 24 hours. Underwater use will affect the ability to communicate with the pump, so the range will be much less than during normal use. Extended contact with water could weaken the adhesive used by your infusion sets and Dexcom CGM sensors and cause them to fall off prematurely.

3 CGM Features

CHAPTER 20

CGM Settings

20.1 About Bluetooth Technology

Bluetooth Low Energy technology is a type of wireless communication used in cell phones and many other devices. Your t:slim X2™ pump uses Bluetooth wireless technology communication to wirelessly pair with other devices, such as a CGM. This allows the pump to wirelessly communicate with paired devices securely and only with each other.

20.2 Disconnecting from the Dexcom Receiver

The Dexcom G6 CGM only allows pairing with one medical device at a time. Ensure your transmitter is not connected to the receiver before pairing with the pump by doing the following:

Before entering your CGM transmitter ID into the pump, turn off the Dexcom G6 receiver and wait 15 minutes. This allows the Dexcom G6 transmitter to forget the connection currently in place with the Dexcom G6 receiver.

NOTE

It is not enough to Stop the Sensor Session on your Dexcom receiver prior to pairing to the pump. The receiver power must be completely off in order to avoid connection problems.

You may still use a smartphone with the Dexcom G6 CGM app and your pump simultaneously with the same transmitter ID.

20.3 Entering Your Transmitter ID

To activate the Bluetooth wireless technology communication, you need to enter the unique transmitter ID into your pump. Once the transmitter ID has been entered into your pump, the two devices can be paired, allowing your sensor glucose readings to be displayed on your pump.



If you need to replace your transmitter, you will need to enter the new transmitter ID into your pump. If you need to replace your pump, you will need to re-enter the transmitter ID into your pump.

1. Remove the transmitter from its packaging.

2. From the *Home* screen, tap **OPTIONS**.
3. Tap the **Down Arrow**.
4. Tap **My CGM**.
5. Tap **Transmitter ID**.
6. Using the on-screen keypad, enter the unique transmitter ID.

The transmitter ID can be found on the bottom of your transmitter.

The letters I, O, V, and Z are not used in transmitter IDs and should not be entered. If one of these letters is entered, you will be notified that an invalid ID was entered and prompted to enter a valid ID.

7. Tap .
8. To make sure that the correct transmitter ID is entered, you will be prompted to enter it a second time.
9. Repeat step 6 above, then tap .

If the transmitter IDs you entered do not match you will be prompted to start the process again.

- ✓ Once matching values have been entered, you will be returned to the *CGM Settings* screen and the transmitter ID you entered will be highlighted in yellow.

10. Tap .

20.4 Setting CGM Volume

You can set the sound pattern and volume for CGM alerts and prompts to meet your individual needs. Reminders, alerts, and alarms for pump functions are separate from alerts and errors for CGM functions and do not follow the same pattern and volume.

To set your sound volume, see [Section 4.12 Sound Volume](#).

CGM Volume options:

Vibrate

You can set your CGM to alert you with vibration rather than sound. The only exception to this is the fixed low alert at

55 mg/dL, which alerts you as a vibration first, followed by beeps 5 minutes later if not confirmed.

Soft

When you want your alert to be less noticeable. This sets all alerts and alarms to lower volume beeps.

Normal

The default profile when you receive your pump. This sets all alerts and alarms to higher volume beeps.

HypoRepeat

Very similar to normal profile, but it continuously repeats the fixed low alert every 5 seconds until your sensor glucose reading rises above 55 mg/dL or the alert is confirmed. This can be helpful if you want extra alerts for severe low sensor glucose readings.

The CGM Volume setting that you choose applies to all CGM alerts, errors, and prompts which have their own unique sound pattern, tone and volume. This allows you to identify each alert and error and its meaning.

The fixed low alert at 55 mg/dL cannot be turned off or changed.

The Soft, Normal, and HypoRepeat options have the following sequence:

- The first alert is vibrate only.
- If the alert is not confirmed in 5 minutes, the system vibrates and beeps.
- If the alert is not confirmed in 5 more minutes, the system vibrates and beeps louder. This continues at the same volume every 5 minutes until confirmed.
- If the alert is confirmed and your sensor glucose readings continue to be at or below 55 mg/dL your system repeats the alert sequence in 30 minutes (HypoRepeat option only).

Sound Option Descriptions

CGM Volume	Vibrate	Soft	Normal	HypoRepeat
High Alert	2 long vibrates	2 long vibrates + 2 low beeps	2 long vibrates + 2 medium beeps	2 long vibrates + 2 medium beeps
Low Alert	3 short vibrates	3 short vibrates + 3 low beeps	3 short vibrates + 3 medium beeps	3 short vibrates + 3 medium beeps
Rise Alert	2 long vibrates	2 long vibrates + 2 low beeps	2 long vibrates + 2 medium beeps	2 long vibrates + 2 medium beeps
Fall Alert	3 short vibrates	3 short vibrates + 3 low beeps	3 short vibrates + 3 medium beeps	3 short vibrates + 3 medium beeps
Out of Range Alert	1 long vibrate	1 long vibrate + 1 low beep	1 long vibrate + 1 medium beep	1 long vibrate + 1 medium beep
Fixed Low Alert	4 short vibrates + 4 medium tone beeps	4 short vibrates + 4 medium tone beeps	4 short vibrates + 4 medium tone beeps	4 short vibrates + 4 medium tone beeps + pause + repeat sequence
All Other Alerts	1 long vibrate	1 long vibrate + 1 low beep	1 long vibrate + 1 medium beep	1 long vibrate + 1 medium beep

To Select Your CGM Volume:

1. From the *Home* screen, tap **OPTIONS**.
2. Tap the **Down Arrow**.
3. Tap **Device Settings**.
4. Tap **Sound Volume**.
5. Tap the **Down Arrow**.
6. Tap **CGM Alerts**.
7. Tap **Vibrate, Soft, Normal** or **HypoRepeat** to select.
- ✓ Once a value is selected, the pump will return to the previous screen.
8. Tap .

20.5 CGM Info

CGM Info contains important information about your device. The following can be found in CGM Info:

- Firmware Revision

- Hardware Revision

You can view this information at any time.

1. From the *Home* screen, tap **OPTIONS**.
2. Tap the **Down Arrow**.
3. Tap **My CGM**.
4. Tap the **Down Arrow**.
5. Tap **CGM Info**.

This Page is Intentionally Left Blank

3 CGM Features

CHAPTER 21

Setting CGM Alerts

Setting Your CGM Alerts

You can create personal settings for how and when you want the System to tell you what is happening.

NOTE

The following applies to setting CGM alerts on the pump. If you are using a CGM app, any alerts that have been set up in the app are not automatically transferred to the pump and must be set up separately.

The High and Low Alerts tell you when your sensor glucose readings are outside your target sensor glucose range.

Rise and Fall (rate of change) Alerts let you know when your sensor glucose levels are changing fast.

The System also has a 55 mg/dL Fixed Low Alert that cannot be changed or turned off. This safety feature tells you your sensor glucose level may be dangerously low.

The Out of Range Alert notifies you when the transmitter and pump are not communicating. Keep the transmitter and the pump within 20 feet (6 meters)

of each other without obstruction. When the transmitter and the pump are too far apart, you will not get sensor glucose readings or alerts.

High and Low Glucose Alerts

You can personalize the High and Low Alerts which tell you when your sensor glucose readings are outside of your target sensor glucose range. When you have both your High and Low Alerts turned on, a grey zone on your trend graph shows your target range. The default for the High Alert is on, 200 mg/dL. The default for the Low Alert is on, 80 mg/dL. Consult with your healthcare provider before setting the High and Low Glucose Alert setting.

21.1 Setting Your High Glucose Alert and Repeat Feature

1. From the *Home* screen, tap **OPTIONS**.
2. Tap the **Down Arrow**.
3. Tap **My CGM**.
4. Tap **CGM Alerts**.

5. Tap **High and Low**.
6. To Set the High Alert, tap **High Alert**.
7. Tap **Alert Me Above**.

The default setting for the High Alert is 200 mg/dL.

NOTE

To turn off the High Alert, tap the on/off toggle. The screen will indicate that off is selected.

8. Using the on-screen keypad, enter the value above which you want to be notified. It can be set between 120 and 400 mg/dL in 1 mg/dL increments.
9. Tap .

The repeat feature allows you to set a time for the High Alert to sound again and display on your pump as long as your sensor glucose reading remains above the High Alert value. The default value is: Never (the alert will not sound again). You can set the repeat feature to sound again

every 15 minutes, 30 minutes, 1 hour, 2 hours, 3 hours, 4 hours, or 5 hours when your sensor glucose reading remains above the High Alert value.

To Set Up the Repeat Feature:

10. Tap **Repeat**.
11. To select the repeat time, tap the time you want the alert to sound again. For instance, if you select 1 hr, the alert will sound every hour as long as your sensor glucose reading remains above the High Alert value.

Use the up and down arrows to view all Repeat options.

- ✓ Once a value is selected, the pump will return to the previous screen.

12. Tap .

21.2 Setting Your Low Glucose Alert and Repeat Feature

1. From the *Home* screen, tap **OPTIONS**.

2. Tap the **Down Arrow**.
3. Tap **My CGM**.
4. Tap **CGM Alerts**.
5. Tap **High and Low**.
6. To Set the Low Alert, tap **Low Alert**.
7. Tap **Alert Me Below**.

The default setting for the Low Alert is 80 mg/dL.

NOTE

To turn off the Low Alert, tap the on/off toggle. The screen will indicate that off is selected.

8. Using the on-screen keypad, enter the value below which you want to be notified. It can be set between 60 and 100 mg/dL in 1 mg/dL increments.
9. Tap .

The repeat feature allows you to set a time for the Low Alert to sound again and display on your pump as

long as your sensor glucose reading remains below the Low Alert value. The default value is: Never (the alert will not sound again). You can set the repeat feature to sound again every 15 minutes, 30 minutes, 1 hour, 2 hours, 3 hours, 4 hours, or 5 hours when your sensor glucose reading remains below the Low Alert value.

To Set Up the Repeat Feature:

10. Tap **Repeat**.
11. To select the repeat time, tap the time you want the alert to sound again. For instance, if you select 1 hr, the alert will sound every hour as long as your sensor glucose reading remains below the Low Alert Value.

Use the up and down arrows to view all repeat options.

- ✓ Once a value is selected, the pump will return to the previous screen.

12. Tap .

21.3 Rate Alerts

Rate alerts tell you when your sensor glucose levels are rising (Rise Alert) or falling (Fall Alert) and by how much. You can choose to be alerted when your sensor glucose reading is rising or falling 2 mg/dL or more per minute, or 3 mg/dL or more per minute. The default value for both the Fall Alert and the Rise Alert is off. When turned on, the default is 3 mg/dL. Consult with your healthcare provider before setting the Rise and Fall Alerts.

Examples

If you set your Fall Alert to 2 mg/dL per minute and your sensor glucose readings fall at this rate or faster, the CGM FALL ALERT with one arrow pointing down shows. The pump

vibrates or beeps according to your CGM Volume selection.

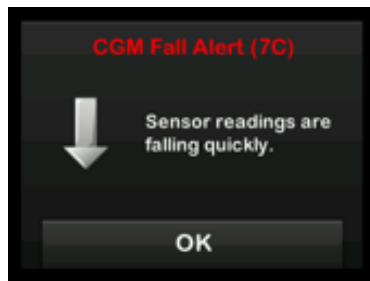

If you set your Rise Alert to 3 mg/dL per minute and your sensor glucose readings rise at this rate or faster, the CGM RISE ALERT with two arrows pointing up shows. The pump vibrates or beeps according to your CGM Volume selection.

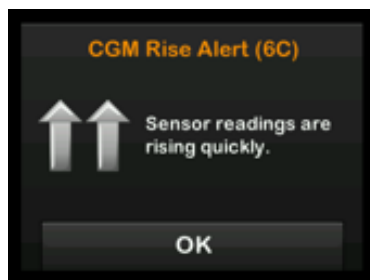

21.4 Setting Your Rise Alert

1. From the *Home* screen, tap **OPTIONS**.
2. Tap the **Down Arrow**.
3. Tap **My CGM**.
4. Tap **CGM Alerts**.
5. Tap **Rise and Fall**.
6. Tap **Rise Alert**.
7. To select the default of 3 mg/dL/min, tap .

To change your selection, tap **Rate**.

NOTE

To turn off the Rise Alert, tap the on/off toggle.

8. Tap **2 mg/dL/min** to select.
- ✓ Once a value is selected, the pump will return to the previous screen.
9. Tap .

21.5 Setting Your Fall Alert

1. From the *Home* screen, tap **OPTIONS**.
2. Tap the **Down Arrow**.
3. Tap **My CGM**.
4. Tap **CGM Alerts**.
5. Tap **Rise and Fall**.
6. Tap **Fall Alert**.
7. To select the default of 3 mg/dL/min, tap .

To change your selection, tap **Rate**.

NOTE

To turn off the Fall Alert, tap the on/off toggle.

8. Tap **2 mg/dL/min** to select.
- ✓ Once a value is selected, the pump will return to the previous screen.
9. Tap .

21.6 Setting Your Out of Range Alert

The range from the transmitter to the pump is up to 20 feet (6 meters) without obstruction.

The Out of Range Alert lets you know when your transmitter and pump are not communicating with each other. The alert is on by default.

PRECAUTION

We recommend that you leave the CGM Out of Range Alert on to notify you if your CGM is disconnected from your pump whenever you are not actively monitoring your pump status. Your CGM is providing the data that the Basal-IQ™ technology needs to make predictions to suspend insulin delivery.

Keep the transmitter and the pump within 20 feet (6 meters) of each other without obstruction. To ensure communication, it is suggested that you face your pump screen out and away from the body, and wear the pump on the same side of the body that you wear your CGM. When the transmitter and pump are not communicating, you will not get sensor glucose readings or

alerts. The default value is on and will alert after 20 minutes.



The Out Of Range symbol appears on the pump *Home* screen and on the *Out of Range Alert* screen (if turned on) when the transmitter and pump are not communicating. The amount of time out of range also shows on the alert screen. It will continue to re-alert until the transmitter and pump are back in range.

To Set Your Out of Range Alert:

1. From the *Home* screen, tap **OPTIONS**.
2. Tap the **Down Arrow**.
3. Tap **My CGM**.
4. Tap **CGM Alerts**.
5. Tap **Out of Range**.

The default is set to on and the time is set to 20 minutes.

6. To change the time, tap **Alert After**.

7. Using the on-screen keypad, enter the time after which you want to be alerted (between 20 minutes and 3 hours and 20 minutes) then tap .
8. Tap .

3 CGM Features

CHAPTER 22

Start or Stop a CGM Sensor Session

22.1 Start the Sensor

To start a CGM session, follow the steps below.

1. From the *Home* screen, tap **OPTIONS**.
2. Tap the **Down Arrow**.
3. Tap **My CGM**.
4. Tap **START SENSOR**.

- ✓ Once you start a sensor session, the **START SENSOR** option is replaced with **STOP SENSOR**.

The following prompt displays prompting you to either enter the sensor code, or to skip this step. If you choose to enter the sensor code, you will not be prompted to calibrate for the duration of the sensor session. For information about Dexcom G6 CGM sensor codes,

visit the manufacturer's website for applicable user guides.

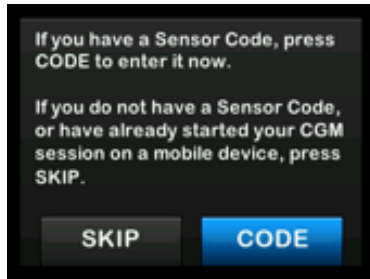

Tap **CODE** to enter the 4-digit sensor code. If you don't have a code, or if you have already started a sensor session with the Dexcom GG CGM app, you can tap **SKIP**.

If you don't enter a code into either the t:slim X2 pump or the Dexcom G6 CGM app you will need to calibrate your sensor every 24 hours. A prompt to calibrate will be displayed on the pump and on the Dexcom G6 CGM app.

5. Tap  to confirm.

- ✓ The *SENSOR STARTED* screen will appear to let you know your sensor startup has begun.
 - ✓ Your pump will return to the *CGM Home* screen with the 3 hour trend graph displayed.
6. Check your pump *CGM Home* screen 10 minutes after starting your sensor session to make sure your pump and transmitter are communicating. The antenna symbol should be to the right of the battery indicator and should be white.
 7. If you see the out of range symbol below the insulin level indicator, and the antenna symbol is grayed out, follow these troubleshooting tips:
 - a. Make sure your pump and transmitter are within 20 feet (6 meters) of each other without obstruction. Re-check in 10 minutes to see if the out of range symbol is still active.
 - b. If the pump and transmitter are still not communicating, check

the *My CGM* screen to make sure the correct transmitter ID is entered.

- c. If the correct transmitter ID is entered and the pump and transmitter are still not communicating, contact Customer Technical Support.

22.2 Sensor Startup Period

As an example, the Dexcom G6 sensor needs a 2-hour startup period to adjust to being under your skin. You will not get sensor glucose readings or alerts until the 2-hour startup period ends and you complete your first calibrations. For information about Dexcom G6 CGM sensor startup periods, visit the manufacturer's website for applicable user guides.

During the startup period, the *CGM Home* screen on your pump shows a 2-hour countdown symbol in the upper right portion of the screen. The countdown symbol fills in over time to show that you are getting closer to the end of the startup period.

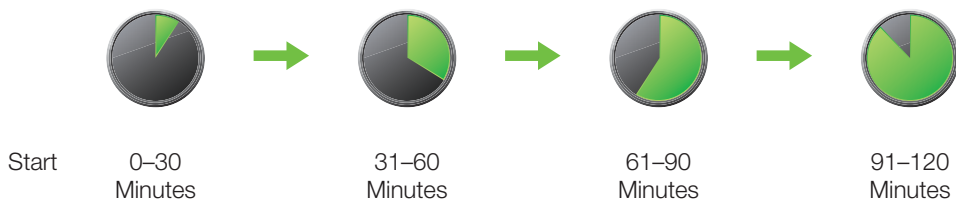

⚠ WARNING

Continue to use a BG meter and test strips in order to make treatment decisions during the 2-hour startup period.

Examples

For example, if you started your sensor session 20 minutes ago, you would see this countdown symbol on the *CGM Home* screen.



If you started your sensor session 90 minutes ago, you would see this countdown symbol on the *CGM Home* screen.



At the end of the 2-hour startup period, if you have not entered the sensor code, then you will be prompted to enter 2 calibration values. 2 blood drops will appear in the place where the countdown symbol was. If you entered a sensor code, the countdown symbol will be replaced with the current CGM reading.



If you did not enter a sensor code, then follow the instructions in the next section to calibrate your sensor. Skip the calibration instructions if you entered a sensor code. You may enter a calibration into the System at any time, even if you have already entered sensor code. Pay attention to your symptoms, and if they do not match the current CGM readings, you may choose to enter a calibration.

Ending Your Sensor Session



When the sensor session ends, you will need to replace the sensor and start a new sensor session. In some cases your sensor session may end early. You may also choose to end the sensor session early.

Sensor glucose alerts and alarms do not work after the sensor session ends. Once the sensor session has ended, CGM readings are not available. If you are using Basal-IQ™ technology, it will not longer be able to predict a low and suspend insulin when a CGM sensor session is ended.

22.3 Automatic Sensor Shut-Off

Your t:slim X2 pump tells you how much time you have left until your sensor session is complete. The *SENSOR EXPIRING SOON* screen shows at 6 hours remaining, 2 hours remaining, and 30 minutes remaining before your session ends. You will continue to receive sensor glucose readings after each reminder.

When you see the *SENSOR EXPIRING SOON* screen:

1. Tap  to return to the previous screen.
- ✓ The *SENSOR EXPIRING SOON* screen will show again when there are 2 hours remaining, and when there are 30 minutes remaining.
- ✓ After the final 30 minutes, the *REPLACE SENSOR* screen is displayed.
2. Tap .
- ✓ The *CGM Home* screen will appear with the Replace Sensor icon in the

place where sensor glucose readings normally show.

New sensor glucose readings do not show on your pump after your sensor session ends. You must remove your sensor and insert a new sensor.

22.4 Ending a Sensor Session Before Automatic Shut-Off

You can end your sensor session at any time before the automatic sensor shutoff. To end your sensor session early:

1. From the *Home* screen, tap **OPTIONS**.
2. Tap the **Down Arrow**.
3. Tap **My CGM**.
4. Tap **STOP SENSOR**.
5. Tap  to confirm.
- ✓ The *SENSOR STOPPED* screen is temporarily displayed.

- ✓ The *CGM Home* screen will appear with the Replace Sensor icon in the place where sensor glucose readings normally show.

New sensor glucose readings do not show on your pump after your sensor session ends. You must remove your sensor and insert a new sensor.

22.5 Removing the Sensor and Transmitter

▲ WARNING

DO NOT ignore broken or detached sensor wires. A sensor wire could remain under your skin. If a sensor wire breaks off under your skin and you can't see it, don't try to remove it. Contact your healthcare provider. Also seek professional medical help if you have symptoms of infection or inflammation (redness, swelling, or pain) at the insertion site. If you experience a broken sensor, please report this to Customer Technical Support.

For information about removing the Dexcom G6 sensor and Dexcom G6 transmitter, visit the manufacturer's website for applicable user guides.

3 CGM Features

CHAPTER 23

Calibrating Your CGM System

23.1 Calibration Overview

If you did not enter a CGM sensor code when starting a sensor session, you will be prompted to calibrate at the following intervals:

- 2-hour startup: 2 calibrations 2 hours after you start your sensor session
- 12-hour update: 12 hours after the 2 hour start up calibration
- 24-hour update: 24 hours after the 2 hour start up calibration
- Every 24 hours: every 24 hours after the 24-hour update
- When notified

On the first day of your sensor session, you must enter 4 BG values into your pump to calibrate. You must enter 1 BG value to calibrate every 24 hours after your first startup calibration. The pump will remind you when the System needs these calibrations. In addition, you may be prompted to enter additional BG values to calibrate as needed.

▲ PRECAUTION

DO NOT calibrate when your trend arrow is up, double-up, down, or double-down because your BG is changing at more than 2 mg/dL per minute.

When calibrating, you must enter your BG values into the pump by hand. You can use any commercially available BG meter. You must calibrate with accurate BG meter values to get accurate sensor glucose readings.

Follow these important instructions when obtaining BG values for calibration:

- BG values used for calibration must be between 40 to 400 mg/dL and must have been taken within the past 5 minutes.
- Your sensor cannot be calibrated if the glucose value from your BG meter is less than 40 mg/dL. For safety reasons, if your BG is low, first treat your low BG.
- Make sure a sensor glucose reading shows in the upper right portion of the *CGM Home* screen before calibrating.

- Make sure the antenna symbol is visible to the right of the battery indicator on the *CGM Home* screen and is active (white, not greyed out) before calibrating.
- Always use the same meter to calibrate that you routinely use to measure your BG. Do not switch your meter in the middle of a sensor session. BG meter and strip accuracy vary between BG meter brands.
- The accuracy of the BG meter used for calibration may affect the accuracy of sensor glucose readings. Follow your BG meter manufacturer's instructions for BG testing.

23.2 Startup Calibration

If you did not enter a sensor code when starting the sensor session, the system will prompt you to calibrate to provide accurate information.

NOTE

The instructions in this section do not apply if you entered the sensor code when you started the sensor session.

2 hours after you start the sensor session, the *CALIBRATE CGM* screen will appear, letting you know that 2 separate BG values from your meter must be entered. You will not see sensor glucose readings until the pump accepts the BG values.

1. From the *CALIBRATE CGM* screen, Tap .
- ✓ The *CGM Home* screen will appear with two blood drops in the upper right portion of the screen. The two blood drops will stay on the screen until you enter 2 separate BG values to calibrate.
2. Wash and dry your hands, make sure your BG test strips are not expired and have been stored properly, and make sure your meter is properly coded (if required).
3. Take a BG measurement using your BG meter. Carefully apply the blood

sample to the test strip following your meter manufacturer's instructions.

▲ PRECAUTION



DO use fingertips to calibrate from your meter. Blood from other places may be less accurate and not as timely.

4. Tap **OPTIONS**.
5. Tap the **Down Arrow**.
6. Tap **My CGM**.
7. Tap **Calibrate CGM**.
8. Using the on-screen keypad, enter the BG value from your BG meter.

▲ PRECAUTION

To calibrate the System, **DO** enter the exact BG value displayed on your BG meter within 5 minutes of a carefully performed BG meter. Do not enter the sensor glucose readings for calibration. Entering incorrect BG values, BG values obtained more than 5 minutes before entry, or sensor glucose readings might affect sensor accuracy and could result in you missing severe

hypoglycemia (low BG) or hyperglycemia (high BG) events.

9. Tap .
10. Tap  to confirm the calibration.
 - Tap  if the BG value does not exactly match the reading from your BG meter. The on-screen keypad will reappear. Enter the exact reading from your meter.
 - ✓ The *CALIBRATION ACCEPTED* screen will appear.
 - ✓ The *My CGM* screen will appear.
11. Tap **Calibrate CGM** to enter your second BG value.
 - ✓ The on-screen keypad will appear.
12. Wash and dry your hands, make sure your BG test strips are not expired and have been stored properly, and make sure your meter is properly coded (if required).
13. Take a BG measurement using your BG meter. Carefully apply the blood

sample to the test strip following your meter manufacturer’s instructions.

- Follow steps 8–10 to enter your second BG value.

23.3 Calibration BG Value and Correction Bolus

Your t:slim X2 pump uses the BG value entered for calibration to determine if a correction bolus is needed, or to provide other important information about your insulin on board and BG.

- If you enter a calibration value that is above your Target BG in Personal Profiles, a message screen will indicate “YOUR BG IS ABOVE TARGET”. To add a correction bolus, tap . Follow the instructions in [Section 7.2 Correction Bolus Calculation](#) to deliver a correction bolus.
- If you enter a calibration value that is below your Target BG in Personal Profiles, a message screen will indicate “YOUR BG IS BELOW TARGET”, and other important

information will appear on the screen.

- If you enter your Target BG as a calibration value, the pump will return to the *CCM Home* screen.

23.4 24 Hour Calibration Update

Calibrate your CGM System when prompted. If you did not enter the sensor code during sensor session start, then calibration will be at least every 24 hours after your first day of calibrations to make sure your sensor glucose readings remain accurate and close to your BG values. You can enter BG values sooner than 24 hours if you want. If you have not entered any BG values in the past 24 hours, the pump will ask you to enter a BG value to update its calibration.

The *CALIBRATE CGM* screen will appear, letting you know that a BG value from your BG meter must be entered to calibrate. In addition, a blood drop will appear to the right of the antenna symbol and will remain there until a BG value is entered to calibrate.

- From the *CALIBRATE CGM* Screen, Tap .



PRECAUTION

DO use fingertips to calibrate from your meter. Blood from other places may be less accurate and not as timely.

- Tap **OPTIONS**.
- Tap the **Down Arrow**.
- Tap **My CGM**.
- Tap **Calibrate CGM**.
- Using the on-screen keypad, enter the BG value from your BG meter.

PRECAUTION

DO enter the exact BG value displayed on your meter within 5 minutes of using your meter. Don’t enter the Dexcom G6 reading for calibration.

- Tap .
- Tap  to confirm the calibration.

Tap  if the BG value does not exactly match the reading from your meter. The on-screen keypad will appear. Enter the exact reading from your meter.

- ✓ The *CALIBRATION ACCEPTED* screen will appear, followed by the *CGM Home* screen.

23.5 Other Reasons You May Need to Calibrate

You may need to calibrate when your System did not accept the last calibration, or when the BG value you entered for calibration is very different from the sensor glucose reading.

When you see the *CALIBRATE CGM* screen, calibrate using the instructions in the previous chapters.

If you see the *CALIBRATION ERROR* screen, you will be prompted to enter a BG value to calibrate in either 15 minutes or 1 hour, depending on the error.

NOTE

Although it is not required, and you will not be prompted to calibrate, you may enter a calibration into the System at any time, even if you have already entered a sensor code. Pay attention to your symptoms, and if they do not match the current CGM readings, you may choose to enter a calibration.

This Page is Intentionally Left Blank

3 CGM Features

CHAPTER 24

Viewing CGM Data on Your t:slim X2 Insulin Pump

24.1 Overview

▲ WARNING

DO NOT ignore how you feel. If your sensor glucose alerts and readings do not match what you're feeling, use your BG meter to make diabetes treatment decisions or, if needed, seek immediate medical attention.

During an active sensor session, CGM readings are sent to your pump every 5 minutes. This section teaches you how to view your sensor glucose readings and trend information. The trend graph provides additional information that your BG meter does not. It shows your current sensor glucose value, the direction it is changing and how fast it is changing. The trend graph can also show you where your sensor glucose has been over time.

Your BG meter measures glucose in your blood. Your sensor measures glucose from interstitial fluid (the fluid under your skin). Because glucose from different fluids is measured, readings from your BG meter and sensor may not match.

The greatest benefit you get from using continuous glucose monitoring will come from trending information. It is important that you focus on the trends and rate of change on your receiver rather than the exact sensor glucose reading.

Press the **Screen On/Quick Bolus** button to turn the screen on. If a CGM session is active, you will see the *CGM Home* screen with the 3 hour trend graph displayed.

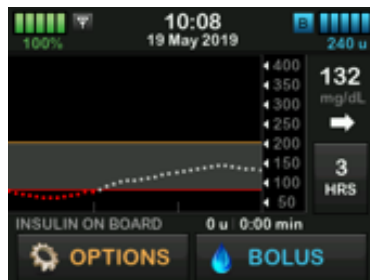

- The current time and date are shown at the top of the screen in the middle.
- Each “dot” on the trend graph is a sensor glucose reading reported every 5 minutes.

- Your High Alert setting shows as an orange line across the trend graph.
- Your Low Alert setting shows as a red line across the trend graph.
- The gray zone highlights your target sensor glucose range, between your High and Low Alert settings.
- Sensor glucose readings are shown in milligrams per deciliter (mg/dL).
- If your sensor glucose reading is between your High and Low Alert settings, it is shown in white.
- If your sensor glucose reading is above your High Alert setting, it is shown in orange.
- If your sensor glucose reading is below your Low Alert setting, it is shown in red.
- If the Low Alert is not set and your sensor glucose reading is 55 mg/dL or lower, it is shown in red.
- The dots on the trend graph display as different colors based on your High and Low Alert settings: white if between High and Low Alert

settings, orange if above High Alert setting, red if below Low Alert setting.

24.2 CGM Trend Graphs

You can view your past sensor glucose trend information on your *CGM Home* screen.

1, 3, 6, 12, and 24 hour trend views can be seen. The 3 hour Trend Graph is the default view and will be shown on the *Home* screen even if a different trend graph was shown when the screen turned off.

Sensor glucose information is only reported for values between 40 and 400 mg/dL. Your trend graph shows a flat line or dots at 40 or 400 mg/dL when your glucose is outside this range.

To view different Trend Graph times, tap on the Trend Graph Time (HRS) to cycle through the options.

3 Hour Trend Graph (default view) shows you your current sensor glucose

reading along with the last 3 hours of sensor glucose readings.

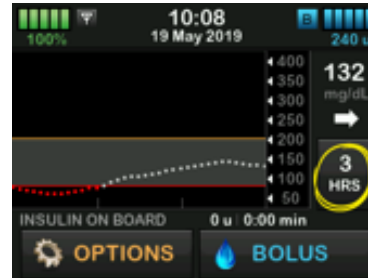

6 Hour Trend Graph shows you your current sensor glucose reading along with the last 6 hours of sensor glucose readings.

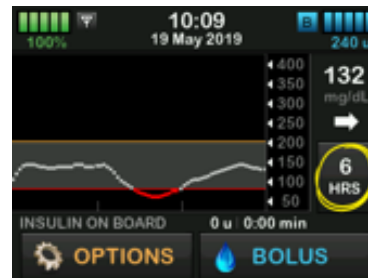

12 Hour Trend Graph shows you your current sensor glucose reading along

with the last 12 hours of sensor glucose readings.



24 Hour Trend Graph shows you your current sensor glucose reading along with the last 24 hours of sensor glucose readings.

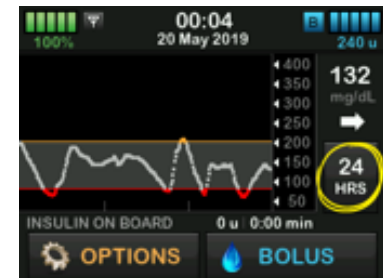

1 Hour Trend Graph shows you your current sensor glucose reading along

with the last 1 hour of sensor glucose readings.

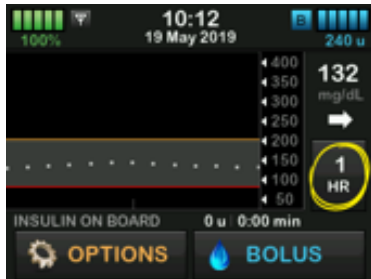

LOW shows when your most recent sensor glucose reading is less than 40 mg/dL.

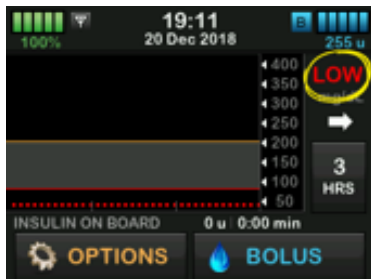

HIGH shows when your most recent sensor glucose reading is greater than 400 mg/dL.

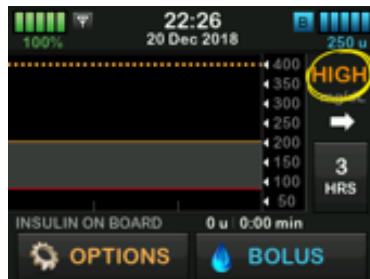

24.3 Rate of Change Arrows

Your rate of change arrows add detail about the direction and speed of sensor glucose change over the last 15–20 minutes.

The trend arrows show below your current sensor glucose reading.









Do not overreact to the rate of change arrows. Consider recent insulin dosing, activity, food intake, your overall trend graph and your BG value before taking action.

If there are missed communications between the sensor and your pump during the last 15–20 minutes due to being out of range or due to an error condition, an arrow may not display. If the trend arrow is missing, and you are concerned that your BG level may be rising or falling, take a BG measurement using your BG meter.

The table below shows the different trend arrows your receiver displays:

Trend Arrow Definitions

	Constant: Your sensor glucose is steady (not increasing/decreasing more than 1 mg/dL each minute). Your sensor glucose could increase or decrease by up to 15 mg/dL in 15 minutes.
	Slowly rising: Your sensor glucose is rising 1–2 mg/dL each minute. If it continued rising at this rate, your sensor glucose could increase up to 30 mg/dL in 15 minutes.
	Rising: Your sensor glucose is rising 2–3 mg/dL each minute. If it continued rising at this rate, your sensor glucose could increase up to 45 mg/dL in 15 minutes.
	Rapidly rising: Your sensor glucose is rising more than 3 mg/dL each minute. If it continued rising at this rate, your sensor glucose could increase more than 45 mg/dL in 15 minutes.

	Slowly falling: Your sensor glucose is falling 1–2 mg/dL each minute. If it continued falling at this rate, your sensor glucose could decrease up to 30 mg/dL in 15 minutes.
	Falling: Your sensor glucose is falling 2–3 mg/dL each minute. If it continued falling at this rate, your sensor glucose could decrease up to 45 mg/dL in 15 minutes.
	Rapidly falling: Your sensor glucose is falling more than 3 mg/dL each minute. If it continued falling at this rate, your sensor glucose could decrease more than 45 mg/dL in 15 minutes.
No Arrow	No rate of change information: The System cannot calculate how fast your sensor glucose is rising or falling at this time.

24.4 CGM History

CGM History displays the historical log of CGM events. At least 90 days of data can be viewed in History. When the maximum number of events is reached, the oldest events are removed from the history log and replaced with the most recent events. The following history sections can be viewed:

- Sessions and Calibrations
- Alerts and Errors
- Complete

Each section above is organized by date. If there are no events associated with a date, the day will not be shown in the list.

The Sessions and Calibrations section includes the start time and date for each Sensor Session, the stop time and date for each Sensor Session, and all calibration BG values entered.

The Alerts and Errors section includes the date and time for all Alerts and Errors that occurred. The letter “D” (D: Alert) before an Alert or Alarm indicates

the time it was declared. The letter “C” (C: Alert) indicates the time it was cleared.

The Complete section includes all information from the Sessions and Calibrations and Alerts and Errors sections as well as any changes to Settings.

1. From the *Home* screen, tap **OPTIONS**.
2. Tap the **Down Arrow**.
3. Tap **History**.
4. Tap **CGM History**.
5. Tap section you want to view. Each section is organized by date. Tap the date to view events from that day. Use the **Down Arrow** to scroll to more dates.

24.5 Missed Readings

If your pump misses CGM readings for a period of time, you will see three dashes where the CGM reading typically displays on the *CGM Home*

screen and on the *CGM Lock* screen. The system will automatically attempt to backfill missing data points up to 6 hours in the past when connectivity is restored and readings begin to appear. If the sensor glucose number or trend arrow is missing, and you are concerned that your BG level may be rising or falling, take a BG measurement using your BG meter.

NOTE

Basal-IQ™ technology will continue working for the first 15 minutes after CGM readings become unavailable. If connectivity is not restored after 20 minutes, Basal-IQ technology will no longer suspend insulin delivery. For more information about the details see [Chapter 29 Basal-IQ Technology Overview](#).

3 CGM Features

CHAPTER 25

CGM Alerts and Errors

This section describes CGM alerts and errors that appear on your *Home* screen. It applies only to the CGM portion of your System. CGM alerts and errors do not follow the same pattern of vibration and beeps as insulin delivery reminders, alerts, and alarms.

For information on insulin delivery reminders, alerts, and alarms, see [Chapters 12 t:slim X2 Insulin Pump Alerts](#), [13 t:slim X2 Insulin Pump Alarms](#), and [14 t:slim X2 Insulin Pump Malfunction](#).

For information on Basal-IQ™ technology alerts, see [Chapter 31 Basal-IQ Technology Alerts](#).

▲ WARNING

If a sensor session is ended, either automatically or manually, Basal-IQ technology is unavailable. In order for Basal-IQ technology to be enabled, a sensor session must be started and either a sensor code entered or the sensor calibrated.

▲ PRECAUTION

You must customize the CGM alert settings on your t:slim X2 pump and the Dexcom G6 CGM app separately. The alert settings apply to the phone and pump separately.

25.1 Startup Calibration Alert

<p>What will I see on the screen?</p> 	<p>What does it mean?</p> <p>2-hour CGM startup period is complete. This will only appear if you did not enter a sensor code.</p> <p>How will the System notify me?</p> <p>1 vibration, then vibration/beep every 5 minutes until confirmed.</p> <p>Will the System re-notify me?</p> <p>Yes, every 15 minutes until you calibrate.</p> <p>How should I respond?</p> <p>Tap OK and enter 2 separate BG values to calibrate the system and start your CGM session.</p>
--	--

25.2 Second Startup Calibration Alert

What will I see on the screen?

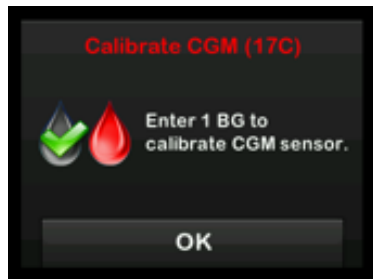

What does it mean?

The System needs an additional BG value to complete startup calibration. This will only appear if you did not enter a sensor code.

How will the System notify me?

1 vibration, then vibration/beep every 5 minutes until confirmed.

Will the System re-notify me?

Yes, every 15 minutes until second calibration is entered.

How should I respond?

Tap  and enter a BG value to calibrate the System and start your CGM session.

25.3 12 Hour Calibration Alert

<p>What will I see on the screen?</p> 	<p>What does it mean?</p> <p>The System needs a BG value to calibrate. This will only appear if you did not enter a sensor code.</p> <p>How will the System notify me?</p> <p>On screen only with no vibration or beep.</p> <p>Will the System re-notify me?</p> <p>Yes, every 15 minutes.</p> <p>How should I respond?</p> <p>Tap OK and enter a BG value to calibrate the system.</p>
--	--

25.4 Incomplete Calibration

What will I see on the screen?



What does it mean?

If you start to enter a calibration value using the keypad and do not complete the entry within 90 seconds, this screen appears.

How will the System notify me?

2 beeps or vibrations depending on Sound Volume selected.

Will the System re-notify me?

Yes, every 5 minutes until confirmed.

How should I respond?

Tap **OK** and complete your calibration by entering the value using the on-screen keypad.

25.5 Calibration Timeout

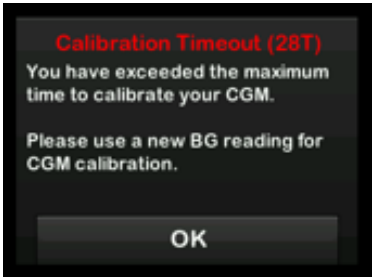
<p>What will I see on the screen?</p> 	<p>What does it mean?</p> <p>If you start to enter a calibration value using the keypad and do not complete the entry within 5 minutes, this screen appears.</p> <p>How will the System notify me?</p> <p>2 beeps or vibrations depending on Sound Volume selected.</p> <p>Will the System re-notify me?</p> <p>Yes, every 5 minutes until confirmed.</p> <p>How should I respond?</p> <p>Tap OK and obtain a new BG value using your meter. Enter the value using the on-screen keypad to calibrate the System.</p>
--	---

25.6 Wait 15 Minute Calibration Error Alert

What will I see on the screen?

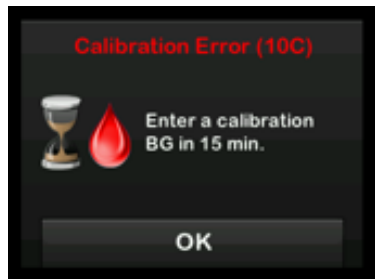

What does it mean?

The sensor cannot calibrate.

How will the System notify me?

1 vibration, then vibration/beep every 5 minutes until confirmed.

Will the System re-notify me?

No.

How should I respond?

Tap **OK** to confirm. Wait 15 minutes then enter 1 more BG value. Wait 15 more minutes. If error screen still appears, enter 1 more BG value. Wait 15 minutes. If no sensor glucose readings appear, the sensor needs to be replaced.

25.7 Calibration Required Alert

<p>What will I see on the screen?</p> 	<p>What does it mean?</p> <p>The System needs a BG value to calibrate. Sensor glucose readings will not be displayed at this time.</p> <p>How will the System notify me?</p> <p>1 vibration, then vibration/beep every 5 minutes until confirmed.</p> <p>Will the System re-notify me?</p> <p>Yes, every 15 minutes.</p> <p>How should I respond?</p> <p>Tap OK and enter a BG value to calibrate the System.</p>
--	--

25.8 CGM High Alert

What will I see on the screen?

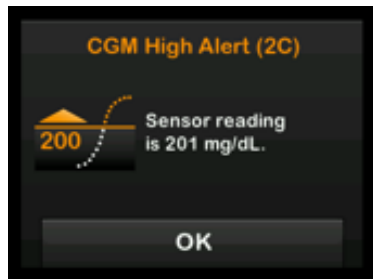

What does it mean?

Your most recent sensor glucose reading is at or above the High Alert setting.

How will the System notify me?

2 vibrations, then 2 vibrations/beeps every 5 minutes until confirmed or your sensor glucose value drops below the Alert level.



Will the System re-notify me?

Only if you have turned on the Repeat feature.

How should I respond?

Tap  to confirm.

25.9 CGM Low Alert

<p>What will I see on the screen?</p> 	<p>What does it mean?</p> <p>Your most recent sensor glucose reading is at or below the Low Alert setting.</p> <hr/> <p>How will the System notify me?</p> <p>3 vibrations, then 3 vibrations/beeps every 5 minutes until confirmed or your sensor glucose value goes above the Alert level.</p> <hr/> <p>Will the System re-notify me?</p> <p>Only if you have turned on the Repeat feature.</p> <hr/> <p>How should I respond?</p> <p>Tap  to confirm.</p>
--	---

25.10 CGM Fixed Low Alert

What will I see on the screen?

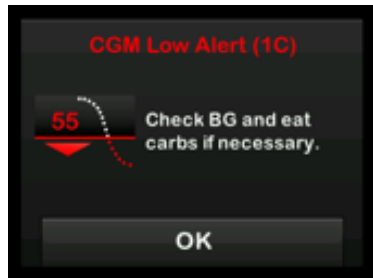

What does it mean?

Your most recent sensor glucose reading is at or below 55 mg/dL.

How will the System notify me?

4 Vibrations, then 4 vibrations/beeps every 5 minutes until confirmed or your sensor glucose value goes above 55 mg/dL.



Will the System re-notify me?

Yes, 30 minutes after each confirmation until your sensor glucose value goes above 55 mg/dL.

How should I respond?

Tap  to confirm.

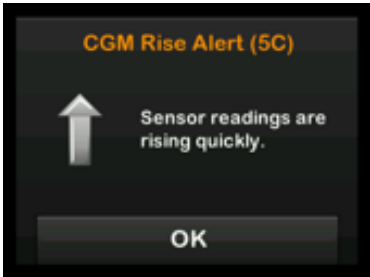
25.11 CGM Rise Alert

<p>What will I see on the screen?</p> 	<p>What does it mean?</p> <p>Your sensor glucose levels are rising at 2 mg/dL per minute or faster (at least 30 mg/dL in 15 minutes).</p> <p>How will the System notify me?</p> <p>2 vibrations, then 2 vibrations/beeps every 5 minutes or until confirmed.</p> <p>Will the System re-notify me?</p> <p>No.</p> <p>How should I respond?</p> <p>Tap  to confirm.</p>
--	--

25.12 CGM Rapid Rise Alert

What will I see on the screen?

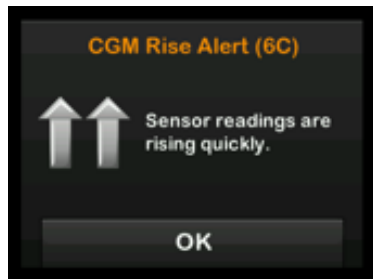

What does it mean?

Your sensor glucose levels are rising at 3 mg/dL per minute or faster (at least 45 mg/dL in 15 minutes).

How will the System notify me?

2 vibrations, then 2 vibrations/beeps every 5 minutes or until confirmed.



Will the System re-notify me?

No.

How should I respond?

Tap  to confirm.

25.13 CGM Fall Alert

<p>What will I see on the screen?</p> 	<p>What does it mean?</p> <p>Your sensor glucose levels are falling at 2 mg/dL per minute or faster (at least 30 mg/dL in 15 minutes).</p> <p>How will the System notify me?</p> <p>3 vibrations, then 3 vibrations/beeps every 5 minutes or until confirmed.</p> <p>Will the System re-notify me?</p> <p>No.</p> <p>How should I respond?</p> <p>Tap  to confirm.</p>
--	---

25.14 CGM Rapid Fall Alert

What will I see on the screen?

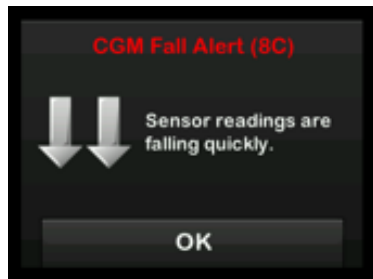

What does it mean?

Your sensor glucose levels are falling at 3 mg/dL per minute or faster (at least 45 mg/dL in 15 minutes).

How will the System notify me?

3 vibrations, then 3 vibrations/beeps every 5 minutes or until confirmed.

Will the System re-notify me?

No.

How should I respond?

Tap **OK** to confirm.

25.15 Unknown Sensor Reading

What will I see on the screen?

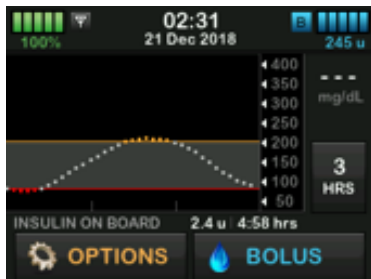

What does it mean?

The sensor is sending sensor glucose readings that the System does not understand. You will not receive sensor glucose readings.

How will the System notify me?

On screen only with no vibration or beep.

Will the System re-notify me?

The 3 dashes will remain on the screen until a new sensor glucose reading is received and displayed in their place.

How should I respond?

Wait 30 minutes for more information from the system. Do not enter BG values for calibration. The system will not use BG values for calibration when “- - -” appears on the screen.

25.16 Out of Range Alert

What will I see on the screen?



What does it mean?

The transmitter and pump are not communicating. You will not receive sensor glucose readings, and Basal-IQ technology is not able to predict low sensor glucose or adjust suspend delivery.

How will the System notify me?

1 vibrate, then vibration/beep every 5 minutes until the transmitter and pump are back in range.

Will the System re-notify me?

Yes, if the transmitter and pump remain out of range.

How should I respond?

Tap  to confirm and move the transmitter and pump closer together, or remove the obstruction between them.

⚠ WARNING

Basal-IQ technology can only suspend insulin delivery when your CGM is in range. If you go out of range during insulin suspension, insulin will resume at the current profile rate.

25.17 Low Transmitter Battery Alert

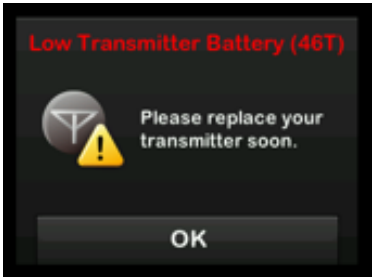
<p>What will I see on the screen?</p> 	<p>What does it mean?</p> <p>Transmitter battery is low.</p> <p>How will the System notify me?</p> <p>1 vibration, then vibration/beep every 5 minutes until confirmed.</p> <p>Will the System re-notify me?</p> <p>Yes, the alarm will notify you when there are 21, 14, and 7 days of transmitter battery life remaining.</p> <p>How should I respond?</p> <p>Tap OK to confirm. Replace the transmitter as soon as possible.</p>
--	--

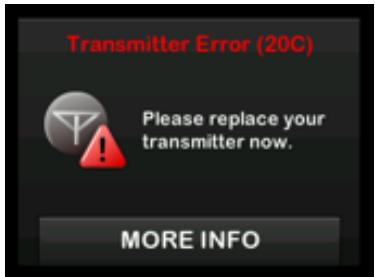

25.18 Transmitter Error

<p>What will I see on the screen?</p> 	<p>What does it mean?</p> <p>The transmitter has failed and the CGM session has stopped.</p> <p>How will the System notify me?</p> <p>1 vibration, then vibration/beep every 5 minutes.</p> <p>Will the System re-notify me?</p> <p>No.</p> <p>How should I respond?</p> <p>Tap MORE INFO. A screen notifying you that your CGM session has stopped but insulin delivery continues will appear.</p> <p>Replace the transmitter immediately.</p>
--	--

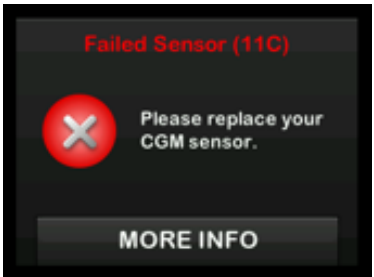
25.19 Failed Sensor Error

<p>What will I see on the screen?</p> 	<p>What does it mean?</p> <p>The sensor is not working properly and the CGM session has stopped.</p> <p>How will the System notify me?</p> <p>1 vibration, then vibration/beep every 5 minutes.</p> <p>Will the System re-notify me?</p> <p>No.</p> <p>How should I respond?</p> <p>Tap MORE INFO. A screen notifying you that your CGM session has stopped but insulin delivery continues will appear.</p> <p>Replace the sensor and begin a new CGM session.</p>
--	---

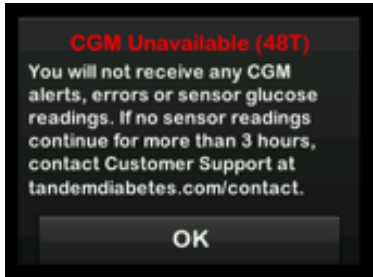
25.20 CGM Unavailable

<p>What will I see on the screen?</p> 	<p>What does it mean?</p> <p>Your CGM session has been stopped for more than 20 minutes and the CGM can no longer be used.</p> <hr/> <p>How will the System notify me?</p> <p>2 vibrations, then 2 vibrations/beeps every 5 minutes or until confirmed.</p> <hr/> <p>Will the System re-notify me?</p> <p>Yes, every 20 minutes until the CGM session is available. If the condition persists for 3 hours, the Failed Sensor alert will be displayed. See Section 25.19 Failed Sensor Error.</p> <hr/> <p>How should I respond?</p> <p>Tap  and contact Customer Technical Support.</p>
--	--

⚠ WARNING

Basal-IQ technology can only suspend insulin delivery when your CGM is in range. If you go out of range during insulin suspension, insulin will resume at the current profile rate.

25.21 CGM System Error

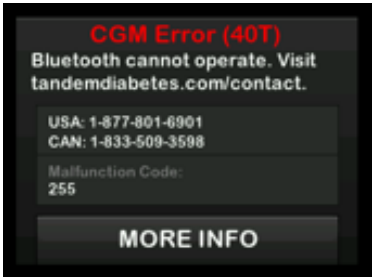
<p>What will I see on the screen?</p> 	<p>What does it mean?</p> <p>Your CGM System is not working properly; the CGM session has stopped and the CGM can no longer be used.</p> <p>How will the System notify me?</p> <p>1 vibration, then vibration/beep every 5 minutes.</p> <p>Will the System re-notify me?</p> <p>No.</p> <p>How should I respond?</p> <p>Tap MORE INFO. A screen notifying you that your CGM System cannot operate but insulin delivery continues will appear. Call Customer Technical Support.</p>
--	--

⚠ WARNING

Basal-IQ technology can only suspend insulin delivery when your CGM is in range. If you go out of range during insulin suspension, insulin will resume at the current profile rate.

This Page is Intentionally Left Blank

3 CGM Features

CHAPTER 26

CGM Troubleshooting

This chapter provides helpful tips and instructions to help you fix issues you may have while using the CGM portion of your System.

If the troubleshooting steps in this chapter do not fix your issue, contact Customer Technical Support.

The following tips are specific to troubleshooting the Dexcom G6 CGM connected to your pump. For more information about Dexcom G6 CGM troubleshooting, visit the manufacturer's website for applicable user guides.

26.1 CGM Pairing Troubleshooting

Possible issue:

Difficulty pairing your Dexcom G6 CGM with your t:slim X2™ insulin pump.

Troubleshooting tip:

The Dexcom G6 CGM only allows pairing with one medical device at a time. Ensure your CGM is not connected to the Dexcom receiver before pairing with the pump. You may still use a smartphone with the Dexcom

G6 CGM app and your t:slim X2 insulin pump simultaneously with the same transmitter ID. See [Section 20.2 Disconnecting from the Dexcom Receiver](#).

26.2 Calibration Troubleshooting

To ensure proper calibration of your CGM, follow these important tips.

Before you take a BG value for calibration, wash your hands, make sure your BG test strips have been stored properly and are not expired and make sure that your meter is properly coded (if required). Carefully apply the blood sample to the test strip following the instructions that came with your meter or test strips.

Do not calibrate if you see the Out of Range symbol in the place where your sensor glucose readings are normally shown on the screen.

Do not calibrate if you see “- -” in the place where you sensor glucose readings are normally shown on the screen.

Do not calibrate if your BG value is below 40 mg/dL or above 400 mg/dL.

26.3 Unknown Sensor Reading Troubleshooting

When your CGM cannot provide a sensor glucose reading “- -” shows in the place where your sensor glucose is normally shown on the screen. This means that the System does not understand the sensor signal temporarily.

Often the System can correct the problem and continue providing sensor glucose readings. If it has been at least 3 hours since your last sensor glucose reading, contact Customer Technical Support.

Do not enter any BG values for calibration when you see “- -” on your screen. The System will not use a BG value for calibration when this symbol is on your screen.

If you see “- -” often during a sensor session, follow the troubleshooting tips below before inserting another sensor.

- Make sure your sensor is not expired.
- Make sure your sensor pod is not dislodged or peeling up.
- Make sure your transmitter is snapped in completely.
- Make sure nothing is rubbing the sensor pod (e.g., clothing, seat belts, etc.).
- Make sure to select a good insertion site.
- Make sure your insertion site is clean and dry before sensor insertion.
- Wipe the bottom of the transmitter with a damp cloth or isopropyl alcohol wipe. Place the transmitter on a clean, dry cloth and air dry for 2–3 minutes.

26.4 Out of Range/No Antenna Troubleshooting

▲ WARNING

Basal-IQ™ technology can only suspend insulin delivery when your CGM is in range. If you go

out of range during insulin suspension, insulin will resume at the current profile rate.

▲ PRECAUTION

AVOID separating the transmitter and receiver by more than 20 feet (6 meters). The transmission range from the transmitter to the receiver is up to 20 feet (6 meters) without obstruction. Wireless communication does not work well through water so the range is much less if you are in a pool, bathtub, or on a water bed, etc. Types of obstruction differ and have not been tested. If your transmitter and receiver are farther than 20 feet (6 meters) apart or are separated by an obstruction, they might not communicate or the communication distance may be shorter and result in you missing severe hypoglycemia (low BG) or hyperglycemia (high BG) events.

If you see the Out of Range icon on your screen in the place where your sensor glucose reading normally shows, then your t:slim X2 pump is not communicating with your transmitter and sensor glucose readings will not show on your screen. Each time you start a new sensor session, wait 10 minutes for your t:slim X2 pump to start communicating with your transmitter. When a sensor session is active, you

may sometimes experience loss of communication for 10 minutes at a time. This is normal.

If you see the Out of Range icon for more than 10 minutes, move your t:slim X2 Pump and CGM transmitter closer together and remove any obstructions. Wait 10 minutes and communication should be restored.

You must enter your transmitter ID correctly into your pump to receive sensor glucose readings (see [Section 20.3 Entering Your Transmitter ID](#)). Make sure you have removed your sensor and stopped your sensor session before checking or changing your transmitter ID. You cannot change your transmitter ID during a sensor session.

If you are still having trouble getting sensor glucose readings, contact Customer Technical Support.

26.5 Failed Sensor Troubleshooting

The System may detect issues with your sensor where it cannot determine your glucose reading. The sensor session ends and the *FAILED SENSOR* screen shows on your t:slim X2 pump. If you see this screen, it means your CGM session has ended.

- Remove your sensor and insert a new sensor.
- To help improve future sensor performance, follow the troubleshooting tips below.
- Make sure your sensor is not expired.
- Make sure your sensor pod is not dislodged or peeling up.
- Make sure your transmitter is snapped in completely.
- Make sure nothing is rubbing the sensor pod (e.g., clothing, seat belts, etc.).
- Make sure you have selected a good insertion site.

26.6 Sensor Inaccuracies

Inaccuracies are usually related to your sensor only and not to your transmitter or pump. Your sensor glucose readings are meant to be used for trending purposes only. The sensor measures glucose in the fluid under the skin—not in blood, and sensor glucose readings are not identical to readings from your BG meter.

⚠ PRECAUTION

To calibrate the System, **DO** enter the exact BG value that your BG meter displays within 5 minutes of a carefully performed BG measurement. Do not enter sensor glucose values for calibration. Entering incorrect BG values, BG values obtained more than 5 minutes before entry, or sensor glucose readings might affect sensor accuracy and could result in you missing severe hypoglycemia (low BG) or hyperglycemia (high BG) events.

If the difference between your sensor glucose reading and BG value is greater than 20% of the BG value for sensor readings >80 mg/dL or greater than 20 mg/dL for sensor readings <80 mg/dL, wash your hands and take

another BG measurement. If the difference between this second BG measurement and the sensor is still greater than 20% for sensor readings >80 mg/dL or greater than 20 mg/dL for sensor readings <80 mg/dL, recalibrate your sensor using the second BG value. The sensor glucose reading will correct over the next 15 minutes. If you see differences between your sensor glucose readings and BG values outside of this acceptable range, follow the troubleshooting tips below before inserting another sensor:

- Make sure your sensor is not expired.
- Make sure you do not calibrate when “- -” or the Out of Range icon are on the screen.
- Do not use alternative BG site testing (blood from your palm or forearm, etc.) for calibration as alternative site readings may be different than those from a BG value. Use a BG value only from your fingers for calibration.
- Use only BG values between 40–400 mg/dL for calibration. If one or

more of your values is outside of this range, the receiver will not calibrate.

- Use the same meter you routinely use to measure your BG to calibrate. Do not switch your meter in the middle of a sensor session. BG meter and strip accuracy vary between BG meter brands.
- Before taking a BG measurement for calibration, wash your hands, make sure your BG test strips have been stored properly and are not expired and make sure that your meter is properly coded (if required). Carefully apply the blood sample to the test strip following the instructions provided with your meter or test strips.
- Make sure you are using your BG meter following the manufacturer's instructions to get accurate BG values for calibration.

This Page is Intentionally Left Blank

4 Basal-IQ Technology Features

CHAPTER 27

Basal-IQ Technology Important Safety Information

The following includes important safety information related to Basal-IQ™ technology. The information presented in this chapter does not represent all warnings and precautions related to the System. Pay attention to other warnings and precautions listed throughout this user guide as they relate to special circumstances, features, or users.

27.1 Basal-IQ Warnings

▲ WARNING

Basal-IQ technology is not a substitute for active management of your diabetes and is not designed to prevent all hypoglycemia (low BG).

▲ WARNING

Basal-IQ technology suspends insulin; Basal-IQ does not treat low BG. Always pay attention to your symptoms, manage your BG level, and treat according to the recommendations of your healthcare provider.

▲ WARNING

Do not use Basal-IQ technology until you have received training.

▲ WARNING

Basal-IQ technology relies on current CGM sensor readings and will not be able to accurately predict BG levels and suspend insulin delivery if for any reason your CGM is not functioning properly or does not transmit three of the last four sensor readings to your pump.

▲ WARNING

Your CGM is providing the data that Basal-IQ needs to make predictions to suspend insulin delivery. Accordingly, we recommend that you leave the CGM Out of Range Alert on to notify you if your CGM is disconnected from your pump whenever you are not actively monitoring your pump status.

27.2 Basal-IQ Precautions

▲ PRECAUTION

We recommend that you enable the Low Glucose Alert when using Basal-IQ technology so that you will be notified if sensor glucose readings are below your target range, and you can treat low BG according to your healthcare provider's recommendations.

▲ PRECAUTION

The use of hydroxyurea will result in sensor glucose readings that are higher than actual glucose levels. The level of inaccuracy in sensor glucose readings is based on the amount of hydroxyurea in the body. Basal-IQ technology relies on sensor glucose readings to provide high and low glucose alerts, and Basal-IQ technology relies on sensor glucose readings to predict and to suspend insulin delivery if sensor glucose is predicted to go below a predefined threshold. If Basal-IQ technology receives sensor readings that are higher than actual glucose levels, it could result in missed hypoglycemia alerts and errors in diabetes management, such as delivery of excess basal insulin and correction boluses. Hydroxyurea can also result in errors when reviewing, analyzing and interpreting historical patterns for assessing glucose control.

4 Basal-IQ Technology Features

CHAPTER 28

Getting to Know Basal-IQ Technology



28.1 Responsible Use of Basal-IQ Technology

Systems like the t:slim X2™ insulin pump with Basal-IQ™ technology are not substitutes for active diabetes management, as there are common scenarios in which automated systems cannot prevent hypoglycemia. The Basal-IQ technology feature relies on continuous CGM readings and will not be able to predict glucose levels and suspend insulin delivery if your CGM is not working properly or is unable to communicate with your pump. Be sure to always use your pump, cartridges, CGM, and infusion sets as instructed and check them regularly to make sure they are working properly. Always pay attention to your symptoms, actively monitor your BG and sensor glucose levels, and treat according to your healthcare provider's recommendations.

28.2 Explanation of Basal-IQ Icons

If you have a CGM session active and are using the Basal-IQ technology, you may see the following additional icons on your pump screen:

Basal-IQ Technology Icon Definitions

Symbol	Meaning
	The Basal-IQ technology is enabled and the pump is delivering the active Personal Profile basal rate.
	The Basal-IQ technology is currently active. All insulin deliveries have been suspended.

Symbol	Meaning
	The Basal-IQ technology is enabled and active: all insulin deliveries have been suspended.

This Page is Intentionally Left Blank

28.3 Basal-IQ Lock Screen

The *Basal-IQ Lock* screen appears any time you turn on the screen and you are using your pump with a CGM and the Basal-IQ technology enabled. The *Basal-IQ Lock* screen is the same as the *CGM Lock* screen, with the following additions. See [Section 18.3 CGM Lock Screen](#).

1. **Basal-IQ Technology Status:** Indicates the status of the Basal-IQ technology.
2. **CGM Graph Shading:** Red shading indicates the Basal-IQ technology is, or was, active for the period indicated.



28.4 Basal-IQ Home Screen

The *Home* screen with Basal-IQ technology enabled is identical to the *CGM Home* screen, with the following additions. See [Section 18.4 CGM Home Screen](#).

1. **Basal-IQ Technology Status:**
Indicates the status of the Basal-IQ technology.
2. **CGM Graph Shading:** Red shading indicates the Basal-IQ technology is, or was, active for the period indicated.



28.5 Basal-IQ Screen

1. **Basal-IQ Technology on/off:** Turns on, or off, the Basal-IQ technology.
2. **Suspend Alert on/off:** Turns on, or off, the alert indicating when insulin has been suspended.
3. **Resume Alert on/off:** Turns on, or off, the alert indicating when insulin has been resumed after a suspension.

NOTE

If this is the first time using your pump with the Basal-IQ technology, you must have an active sensor session before using the Basal-IQ technology. The Basal-IQ technology is turned on by default and will begin working once there is an active sensor session.

NOTE

The Suspend and Resume Alerts are turned off by default.



This Page is Intentionally Left Blank

4 Basal-IQ Technology Features

CHAPTER 29

Basal-IQ Technology Overview

29.1 Basal-IQ Overview

▲ WARNING

Basal-IQ™ technology is not a substitute for active management of your diabetes and is not designed to prevent all hypoglycemia (low BG).

▲ WARNING

Basal-IQ technology suspends insulin; Basal-IQ does not treat low BG. Always pay attention to your symptoms, manage your BG level, and treat according to the recommendations of your healthcare provider.

▲ WARNING

Do not use Basal-IQ technology until you have received training.

▲ PRECAUTION

We recommend that you enable the Low Glucose Alert when using Basal-IQ technology so that you will be notified if sensor glucose readings are below your target range, and you can treat low BG according to your healthcare provider's recommendations.

This section of the user guide provides instructions for using the Basal-IQ technology with your t:slim X2 pump.

Use of the Basal-IQ technology is optional and, when used, allows insulin to be stopped and resumed automatically based on sensor glucose readings. The status of insulin delivery will be displayed on the t:slim X2 pump screen. In order to use this feature you will need to utilize the CGM features as outlined in [Section 3 CGM Features](#).

29.2 How Basal-IQ Works

▲ WARNING

Basal-IQ technology relies on current CGM sensor readings and will not be able to accurately predict BG levels and suspend insulin delivery if for any reason your CGM is not functioning properly or does not transmit three of the last four sensor readings to your pump.

▲ WARNING

Your CGM is providing the data that Basal-IQ needs to make predictions to suspend insulin delivery. Accordingly, we recommend that you leave the CGM Out of Range Alert on to notify you if your CGM is disconnected from your pump whenever you are not actively monitoring your pump status.

The Basal-IQ technology utilizes CGM sensor readings to stop and resume insulin based on the current sensor value and a 30 minute future predicted value along with the following five rules:

1. Insulin delivery is suspended if the current CGM sensor reading is less than 70 mg/dL.

- Insulin delivery is suspended if the sensor glucose value is predicted to be less than 80 mg/dL in 30 minutes.

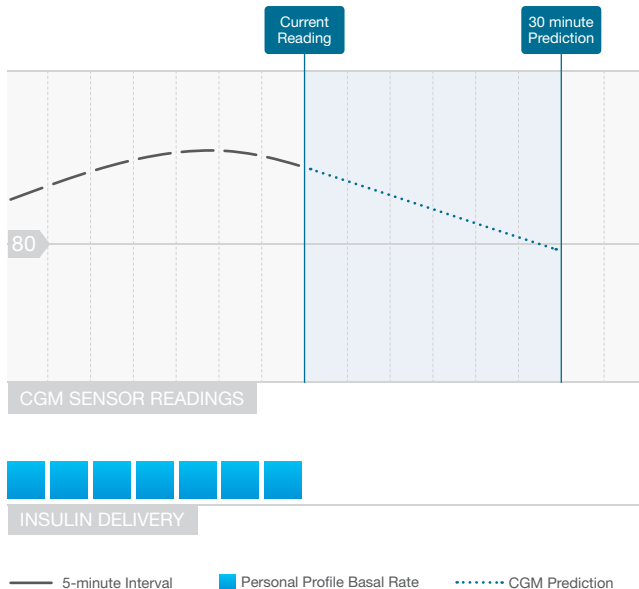

Basal-IQ Insulin Delivery Suspend

NOTE

The diagrams depicted here are sample representations only, and not to be interpreted as actual system performance.

NOTE

During a Basal-IQ suspension of insulin delivery, any correction, food or quick bolus will continue until completed. Any remaining portion of an extended bolus will be canceled. All basal insulin delivery will stop.

NOTE

If insulin is suspended while a Temp Rate is active, the temp rate timer will remain active. The Temp Rate will be resumed when insulin delivery is resumed as long there is time remaining on the Temp Rate timer.

- Basal insulin delivery is resumed once the current CGM sensor reading increases compared to the previous reading.

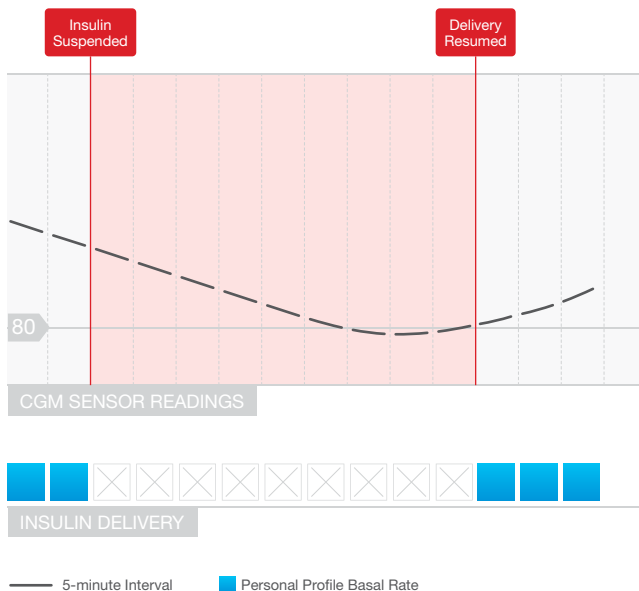

Basal-IQ Insulin Resume

- Basal insulin delivery will also be resumed if the 30 minute predicted CGM reading is above 80 mg/dL, even if the CGM reading has not increased compared to the previous reading.

NOTE

The diagrams depicted here are sample representations only, and not to be interpreted as actual system performance.

- Basal insulin delivery is resumed if insulin delivery has been suspended for 2 hours in a 2.5 hour window.

For example: If insulin is suspended for 2 hours, it will resume for at least 30 minutes. After 30 minutes have passed, if either rule 1 or 2 above is true, then insulin will be suspended.

NOTE

If you need to calibrate your sensor while Basal-IQ technology is currently active, and insulin deliveries have been automatically suspended, insulin delivery will automatically be resumed if the CGM sensor reading is above 70 mg/dL. The Basal-IQ technology requires three new CGM sensor readings to make a prediction after a sensor calibration.

29.3 Turn Basal-IQ On and Off

Once you have a CGM sensor session started, and the CGM has been calibrated, the Basal-IQ technology can be turned on or off by following the steps below.

- From the *Home* screen, tap **OPTIONS**.

- Tap **My Pump**.
- Tap **Basal-IQ**.
- Tap the **ON/OFF** toggle.
- Tap **SAVE**.

Once turned on, the Basal-IQ technology alert settings are displayed. The Suspend Alert and the Resume Alert can be set to on or off depending on your preference. By default alerts are set to the off position. See [Chapter 31 Basal-IQ Technology Alerts](#) to learn more about these alerts.

NOTE

If the Basal-IQ technology is active, and insulin delivery has been suspended, and you turn the feature off, insulin delivery will be resumed at the current profile rate.

NOTE

In most cases, the Basal-IQ technology will be turned on by default, and this step may not be necessary.

This Page is Intentionally Left Blank

4 Basal-IQ Technology Features

CHAPTER 30

Viewing Basal-IQ Technology Status on Your t:slim X2 Pump

30.1 Overview

Status indicators and additional informational indicators show the different states of the Basal-IQ™ technology. This section explains how to interpret these different indicators and understand the information.

30.2 Basal-IQ Status Indicators

The Basal-IQ technology is closely related to the CGM data and has been directly integrated into the CGM screens. Please review [Chapter 24](#) to understand more about viewing CGM data on your pump. When the Basal-IQ technology is off and a sensor session is active, there will be no changes to the screens that you use for viewing CGM data.

When the Basal-IQ technology is on, the CGM Trend Graph will have an additional diamond icon in the top left corner. This icon has two states. When the Basal-IQ technology is on but not active (i.e. insulin is being delivered

normally), the diamond icon will be gray as depicted below.



When the Basal-IQ technology is enabled and active (i.e. insulin delivery has been suspended), the lower half of the diamond icon will be red. In addition to the diamond icon, other screen visuals indicate that insulin has been suspended, including:

- A black S in a red box will be displayed in the status area to the right of the time and date.
- A red bar will be visible over the CGM trend graph.
- **OPTIONS** will expand and the text **ALL DELIVERIES STOPPED** will be displayed.

BOLUS will no longer be available.

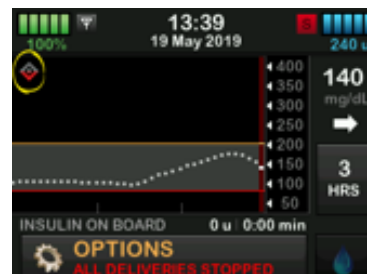

▲ WARNING

Basal-IQ technology relies on current CGM sensor readings and will not be able to accurately predict BG levels and suspend insulin delivery if for any reason, your CGM is not functioning properly or does not transmit three of the last four sensor values to your pump.

▲ PRECAUTION

Your CGM is providing the data that Basal-IQ needs to make predictions to suspend insulin delivery. Accordingly, we recommend that you leave the CGM Out of Range Alert on to notify you if your CGM is disconnected from your pump whenever you are not actively monitoring your pump status.

30.3 Basal-IQ History

The historical log of the Basal-IQ technology events can be found under the Pump History in the *Options* menu. At least 90 days of data can be viewed in the History. When the maximum number of events is reached, the oldest events are removed from the history log and replaced with the most recent events.

The Basal-IQ history shows the historical log of the Basal-IQ technology status, including when the feature is enabled or disabled, as well as the time that insulin suspended and resumed.

1. From the *Home* screen, tap **OPTIONS**.
2. Tap the **Down Arrow**.
3. Tap **History**.
4. Tap **Pump History**.
5. Tap the **Down Arrow**.

6. Tap **Basal-IQ**. The dates that contain Basal-IQ history are displayed.

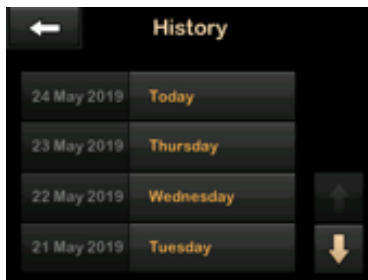

8. Tap **Tandem logo** to return to the *Home* screen.

7. Tap the day for which you want to view the history. The history detail is displayed.



This Page is Intentionally Left Blank

4 Basal-IQ Technology Features

CHAPTER 31

Basal-IQ Technology Alerts

This section describes the Basal-IQ™ technology alerts that appear on your *Home* screen. It applies only to the Basal-IQ technology within your System. The Basal-IQ technology alerts follow the same pattern as other pump alerts according to your Sound Volume selection.

For information on insulin delivery reminders, alerts, and alarms see [Chapters 12 t:slim X2 Insulin Pump Alerts](#), [13 t:slim X2 Insulin Pump Alarms](#), and [14 t:slim X2 Insulin Pump Malfunction](#).

For information on CGM Alerts and Errors, see [Chapter 25 CGM Alerts and Errors](#).

For more information on how to turn the Basal-IQ technology alerts on/off, please see [Section 28.5 Basal-IQ Screen](#).

31.1 Out of Range Alert

<p>What will I see on the screen?</p> 	<p>What does it mean?</p> <p>The transmitter and pump are not communicating and you will not receive sensor glucose readings, and Basal-IQ technology is not able to predict low sensor glucose or suspend insulin delivery.</p> <p>How will the System notify me?</p> <p>1 vibrate, then vibration/beep every 5 minutes until the transmitter and pump are back in range.</p> <p>Will the System re-notify me?</p> <p>Yes, if the transmitter and pump remain out of range.</p> <p>How should I respond?</p> <p>Tap OK to confirm and move the transmitter and pump closer together, or remove the obstruction between them.</p>
--	--

⚠ WARNING

Basal-IQ technology can only suspend insulin delivery when your CGM is in range. If you go out of range during insulin suspension, insulin will resume at the current profile rate.

31.2 Suspend Alert

What will I see on the screen?

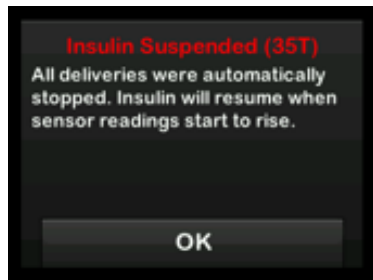

What does it mean?

The Basal-IQ technology has stopped all insulin delivery.

How will the System notify me?

2 sequences of 3 notes or 2 vibrations depending on the volume/vibrate setting selected in your Sound Volume setting.

Will the System re-notify me?

No. You will need to tap **OK** to return to the *Home* screen, or the Resume Alert will take the place of this alert, whichever comes first.

How should I respond?

Tap **OK** and return to current activity.
Optionally, if desired check BG and take carbs.

NOTE

By default, the Suspend Alert is set to off. You will only see this alert if you turn this alert on from the *Basal-IQ Options* menu.

31.3 Resume Alerts

Resume Alert 1

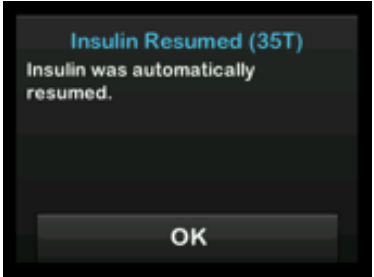
<p>What will I see on the screen?</p> 	<p>What does it mean?</p> <p>The pump has resumed basal insulin delivery.</p> <hr/> <p>How will the System notify me?</p> <p>2 sequences of 3 notes or 2 vibrations depending on the volume/vibrate setting selected in your Sound Volume setting.</p> <hr/> <p>Will the System re-notify me?</p> <p>No. You will need to tap OK to return to the <i>Home</i> screen, or the Suspend Alert will take the place of this alert, whichever comes first.</p> <hr/> <p>How should I respond?</p> <p>Tap OK and return to current activity.</p>
--	---

NOTE

By default, the Resume Alert is set to off. You will only see this alert if you turn this alert on from the *Basal-IQ Options* menu.

Resume Alert 2

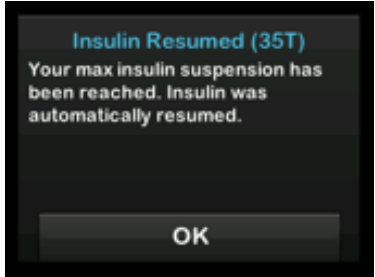
<p>What will I see on the screen?</p> 	<p>What does it mean?</p> <p>This prompt will be displayed when insulin delivery is automatically resumed after being suspended for 2 hours in a 2.5 hour period.</p> <hr/> <p>How will the System notify me?</p> <p>2 sequences of 3 notes or 2 vibrations depending on the volume/vibrate setting selected in your Sound Volume setting.</p> <hr/> <p>Will the System re-notify me?</p> <p>No. You will need to tap OK to return to the <i>Home</i> screen, or the Suspend Alert will take the place of this alert, whichever comes first.</p> <hr/> <p>How should I respond?</p> <p>Tap OK and return to current activity.</p>
--	---

4 Basal-IQ Technology Features

CHAPTER 32

Basal-IQ Technology Clinical Study Overview

32.1 Introduction

The Basal-IQ™ technology utilizes CGM sensor readings to stop and resume insulin based on the current sensor value and a 30 minute future predicted value. The following data represents the clinical performance of the t:slim X2 insulin pump with Basal-IQ technology compared to sensor augmented pump (SAP) therapy alone. The Dexcom G5 Mobile CGM was used in both arms of the study. The performance demonstrated using this sensor is representative of the performance expected from your device when utilizing an iCGM.

32.2 Clinical Study Overview

The goal of this study was to assess the safety and efficacy of the t:slim X2 insulin pump with Basal-IQ technology using a predictive low glucose suspend feature compared to a sensor-augmented pump (SAP) System during day and night use at home under normal conditions.

The system performance was evaluated in a crossover study comparing the 3-week period of Basal-IQ technology use (study arm) to the 3-week period of SAP use (control arm). Participants either started in the study arm (Basal-IQ enabled) or the control arm (SAP), and then after 3 weeks crossed over to the other group. The study population consisted of patients with a clinical diagnosis of type 1 diabetes, 6 to 72 years of age, treated with insulin via an insulin pump or injections for at least 1 year. Females known to be pregnant were not included.

A total of 103 subjects began the randomization period with 102 subjects completing the trial. All participants who had at least one CGM reading in each 3-week period were included in the final analysis. The summary statistics presented here describe the percent time below 70 mg/dL as the primary efficacy endpoint, calculated separately by treatment arm. Analysis of the secondary endpoints and additional CGM metrics was performed in parallel to the analysis of the primary endpoint.

During the clinical study, subjects who used a CGM prior to the study were generally required to use it on at least 85% of days during the prior 4 weeks. Subjects who did not use a CGM prior to the study participated in a 10-14 day Dexcom CGM training period while continuing personal pump or MDI, followed by a 14-28 day SAP training period using the Dexcom study CGM and Tandem study pump.

There were no device related adverse outcomes during the study. The only adverse event reported during the study was a bowel obstruction in one participant while in the control arm (SAP), unrelated to device use. There was one severe hypoglycemic event in the control arm (SAP) as defined as the participant requiring assistance from another person to actively administer carbohydrate, glucagon, or engage in other resuscitative actions. There were no severe hypoglycemic events in the study arm (Basal-IQ enabled).

32.3 Demographics

Baseline demographics of the study cohort are provided in the table below.

Demographics at Enrollment (N=103)

Characteristic	Unit of Measure	Overall	Basal-IQ First (N=52)	SAP First (N=51)
Age	Average age ± std deviation	24 ± 17	25 ± 18	23 ± 16
	Range in years	6 to 72	7 to 64	6 to 72
	<18 years n (% of population)	60 (58%)	29 (56%)	31 (61%)
	≥18 years n (% of population)	43 (42%)	23 (44%)	20 (39%)
Gender	Female n (% of population)	45 (44%)	26 (50%)	19 (37%)
	Male n (% of population)	58 (56%)	26 (50%)	32 (63%)
Daily Insulin Units	Average total units ± std deviation	46 ± 25	44 ± 22	47 ± 28
	Average basal units ± std deviation	22 ± 13	21 ± 14	23 ± 12
	Average bolus units ± std deviation	24 ± 15	23 ± 12	24 ± 18

32.4 Intervention Compliance

The following two tables provide an outline of how often the t:slim X2 insulin pump with Basal-IQ technology and CGM were used during the study period respectively.

Amount of t:slim X2 Insulin Pump with Basal-IQ Technology Use Over the 21-Day Period (N=102)*

% of Time Using the Basal-IQ Technology	Number of Participants	% of Study Population
≥90%	90	88%
80 to <90%	9	9%
70 to <80%	1	<1%
60 to <70%	1	<1%
50 to <60%	0	0%
<50%	1	<1%

*Denominator is the total possible time within 21-day post-randomization study period. Basal-IQ technology use includes time in which Basal-IQ technology was on and available, on and suspended, and on and unavailable. The Basal-IQ technology could be on and unavailable due to unavailable real-time CGM data or various pump statuses (e.g., total suspend time exceeds 120 minutes within a 150-minute period, user-override is active (manual resume), a standard bolus is in progress, no sensor session active, pumping is not started, EGV is above 229 mg/dL, or too many missed readings).

Amount of CGM Use Over the 21-Day Period by Treatment Arm (N=102)

Percentage of Time Using the CGM*	Study Arm (Basal-IQ Enabled)		Control Arm (SAP)	
	# participants	% of population	# participants	% of population
≥90%	75	74%	74	73%
80 to <90%	21	21%	20	20%
70 to <80%	3	3%	3	3%
60 to <70%	0	0%	2	2%
50 to <60%	1	<1%	1	1%
<50%	2	2%	2	2%

*Denominator is the total possible time within the 21-day post-randomization study period. CGM use includes warm-up time.

32.5 Primary Analysis

The primary analysis of this study was to compare the CGM sensor readings less than 70 mg/dL between the study arm (Basal-IQ enabled) and the control arm (SAP). The following data in the table below provides a breakdown of the CGM sensor readings across both study arms and the number of participants whose sensor values were below 70 mg/dL for the given time period.

Percent of CGM Sensor Readings <70 mg/dL (N=102)*

Percent of CGM Glucose Sensor Readings <70 mg/dL	Study Arm (Basal-IQ Enabled)		Control Arm (SAP)	
	# participants	% of population	# participants	% of population
<1%	21	21%	12	12%
1 to <2%	19	19%	15	15%
2 to <3%	18	18%	20	20%
3 to <5%	30	29%	23	23%
≥5%	14	14%	32	31%

**Includes all subjects with at least one CGM glucose reading in each treatment period.*

The average percent of CGM sensor readings less than 70 mg/dL, provided in the table below showed a reduction of 31% in the study arm (Basal-IQ enabled) compared to the control arm (SAP). The treatment difference between the two groups is shown in the table following.

Percent of Average CGM Sensor Readings <70 mg/dL (N=102)*

	Study Arm (Basal-IQ Enabled)	Control Arm (SAP)
Percent of Average CGM Glucose Sensor Readings <70 mg/dL \pm std deviation	3.1% \pm 2.8%	4.5% \pm 3.9%
<i>*Includes all subjects with at least one CGM glucose reading in each treatment period.</i>		

Percent of CGM Sensor Readings <70 mg/dL Treatment Difference (N=102)*

	Basal-IQ Algorithm to SAP Difference (95% CI)**
Percentage of CGM Glucose Sensor Readings <70 mg/dL	-0.8% (-1.1%, -0.5%)
<i>*Includes all subjects with at least one CGM glucose reading in each treatment period.</i>	
<i>**Negative difference denotes less hypoglycemia during the study period using Basal-IQ technology. Based on a repeated measures regression model adjusting for period. Non-parametric analysis since data values had a skewed distribution.</i>	

32.6 Secondary Analysis

The secondary outcomes measures of the clinical study represent characteristics of the sensor glucose profile including time spent in the low (hypoglycemic) range, time spent high (hyperglycemic) range, and the time spent with sensor glucose under control (between 70-80 mg/dL). In the table below, the differences in the percent of time <60 mg/dL, <50 mg/dL, >250 mg/dL. The average sensor glucose was similar across treatment arms.

Secondary Efficacy Outcomes (N=201)*

Characteristic	Unit of Measure	Study Arm (Basal-IQ Enabled)	Control Arm (SAP)
Overall Sensor Glucose Control	Average sensor glucose ± std deviation mg/dL	159 ± 25	159 ± 27
	% 70 – 180 mg/dL ± std deviation	65% ± 15%	63% ± 15%
Hypoglycemia	% <60 mg/dL median (quartiles)	0.9% (0.4%, 1.6%)	1.2% (0.6%, 2.7%)
	% <50 mg/dL median (quartiles)	0.2% (0.1%, 0.5%)	0.3% (0.1%, 0.7%)
Hyperglycemia	% >250 mg/dL median (quartiles)	8% (3%, 13%)	8% (3%, 16%)
	% >180 mg/dL average ± std deviation	32% ± 15%	33% ± 16%

**Includes all subjects with at least one CGM glucose sensor reading in each treatment period.*

The table below provides details about the sensor glucose levels during daytime (6 AM to 10 PM/6:00 to 22:00) versus nighttime (10 PM to 6 AM/22:00 to 6:00). The average sensor glucose in the study arm during daytime was 160 (\pm 26) mg/dL, and 157 (\pm 29) mg/dL during nighttime. In the control arm the average sensor glucose during daytime was 160 (\pm 27) mg/dL and 159 (\pm 30) mg/dL during nighttime. The results were similar in both treatment groups.

Secondary Analysis by Time of Day (N=102)*

		Daytime		Nighttime	
Characteristic	Unit of Measure	Study Arm (Basal-IQ Enabled)	Control Arm (SAP)	Study Arm (Basal-IQ Enabled)	Control Arm (SAP)
% <70 mg/dL	median (quartiles)	2.4% (1.2%, 3.9%)	3.4% (1.8%, 5.2%)	2.7% (0.9%, 4.5%)	3.3% (1.2%, 6.8%)
Overall Sensor Glucose Control	% 70 – 180 mg/dL average \pm std deviation	65% \pm 15%	63% \pm 15%	66% \pm 16%	62% \pm 17%
Hypoglycemia	% <60 mg/dL median (quartiles)	0.8% (0.3%, 1.5%)	1.2% (0.5%, 2.2%)	0.9% (0.2%, 1.9%)	1.2% (0.3%, 3.4%)
	% <50 mg/dL median (quartiles)	0.2% (0.0%, 0.5%)	0.3% (0.1%, 0.6%)	0.2% (0.0%, 0.5%)	0.3% (0.0%, 0.9%)
Hyperglycemia	% >250 mg/dL median (quartiles)	7% (3%, 14%)	9% (3%, 17%)	6% (2%, 12%)	7% (2%, 15%)
	% >180 mg/dL median (quartiles)	32% \pm 16%	33% \pm 16%	31% \pm 17%	33% \pm 19%
<i>*Includes all subjects with at least one CGM glucose sensor reading in each treatment period.</i>					

32.7 Insulin Delivery Differences

The table below provides an overview of the how much insulin was used on average across the study arm (Basal-IQ Enabled) and the control arm (SAP). The amount of basal insulin used in 24 hours was 1.2 units less in the study arm versus the control arm. The 24-hour period combines units of insulin used during the daytime (6 AM to 10 PM/6:00 to 22:00) and nighttime (10 PM to 6 AM/22:00 to 6:00).

Insulin Delivery Summary Statistics (N=102)*

Characteristic	Unit of Measure		Study Arm (Basal-IQ Enabled)	Control Arm (SAP)
Total Insulin Units	24-hour period	average ± std deviation	44.6 ± 20	45.9 ± 20.2
	Daytime	average ± std deviation	35.6 ± 15.6	36.5 ± 15.4
	Nighttime	average ± std deviation	9.0 ± 5.3	9.4 ± 5.6
Basal Insulin Units	24-hour period	average ± std deviation	20.3 ± 10.4	21.5 ± 10.5
	Daytime	average ± std deviation	14.1 ± 7.4	15.0 ± 7.4
	Nighttime	average ± std deviation	6.2 ± 3.2	6.5 ± 3.2
Bolus Insulin Units	24-hour period	average ± std deviation	24.5 ± 12.4	24.5 ± 12.5
	Daytime	average ± std deviation	21.6 ± 10.8	21.6 ± 10.4
	Nighttime	average ± std deviation	2.9 ± 2.9	2.9 ± 3.4

**Includes all subjects with at least one CGM glucose sensor reading in each treatment period.*

32.8 Basal-IQ Technology Performance Accuracy

The following data tables characterize Basal-IQ technology accuracy in successfully predicting low sensor glucose events and subsequently suspending or resuming insulin appropriately. This analysis was performed using previously reported clinical data from Dexcom clinical studies comparing the G5 Mobile CGM to the readings from a laboratory reference method, the Yellow Springs Instrument 2300 STAT Plus™ Glucose Analyzer. This instrument is referred to as the "YSI".

This analysis represents specific CGM and YSI data from 324 subjects, including both adults, 18 years and older, and pediatric, 2 to 17 years of age. Basal-IQ technology was retrospectively applied to each subject's CGM trace to determine when insulin suspensions and resumptions would have occurred, and the appropriateness of the Basal-IQ technology action.

Each insulin suspension and resumption action was then determined to be in one of three categories; True, False, or Missed relative to the corresponding YSI values. True indicating that the suspension or resumption occurrence matched corresponding YSI values and False or Missed indicating differing conditions in which the suspension or resumption occurrence did not match the corresponding YSI values.

The table below provides the accuracy of the Basal-IQ technology suspend actions relative to corresponding YSI values. Predicted suspend actions include when Basal-IQ technology suspended insulin in response to a prediction of CGM readings falling below 80 mg/dL within the next 30 minutes. All suspend actions include predicted suspend actions and the actions when the Basal-IQ technology suspended insulin in response to a real-time CGM reading less than 70 mg/dL.

Percent of CGM Sensor Readings <70 mg/dL

	Predicted Suspend Actions (%)	All Suspend Actions (%)
TRUE Suspends	8,257 (77.55%)	8,276 (77.54%)
FALSE Suspends	2,133 (20.03%)	2,140 (20.05%)
MISSED Suspends	258 (2.42%)	257 (2.41%)
Total Events	10,648 (100.00%)	10,673 (100.00%)

The table below provides the accuracy of the Basal-IQ technology resume actions relative to the corresponding YSI values. The resume actions were analyzed at the first opportunity to resume insulin based on the YSI data, then 5 minutes later and 10 minutes later.

Insulin Resumption Accuracy

	Resume Actions (%)		
	0 minutes	+5 minutes	+10 minutes
TRUE Resumes	1,356 (51.42%)	1,356 (65.57%)	1,356 (73.06%)
FALSE Resumes	332 (12.59%)	332 (16.05%)	332 (17.89%)
MISSED Resumes	949 (35.99%)	380 (18.38%)	168 (9.05%)
Total Events	2,637 (100.00%)	2,068 (100.00%)	1,856 (100.00%)

This Page is Intentionally Left Blank

5 Technical Specifications and Warranty

CHAPTER 33

Technical Specifications

33.1 Overview

This section provides tables of technical specifications, performance characteristics, options, settings, and electromagnetic compliance information for the t:slim X2™ pump. The specifications in this section meet the international standards set forth in IEC 60601-1 and IEC 60601-2-24.

33.2 t:slim X2 Pump Specifications

t:slim X2 Pump Specifications

Specification Type	Specification Details
Classification	External PSU: Class II, Infusion Pump. Internally-powered equipment, Type BF applied part. The risk of ignition of flammable anesthetics and explosive gases by the pump is remote. While this risk is remote, it is not recommended to operate the t:slim X2 pump in the presence of flammable anesthetics or explosive gases.
Size	3.13" x 2.0" x 0.6" (L x W x H) - (7.95 cm x 5.08 cm x 1.52 cm)
Weight (with full disposable)	3.95 ounces (112 grams)
Operating Conditions	Temperature: 41°F (5°C) to 98.6°F (37°C) Humidity: 20% to 90% RH non-condensing
Storage Conditions	Temperature: -4°F (-20°C) to 140°F (60°C) Humidity: 20% to 90% RH non-condensing
Atmospheric Pressure	-1,300 feet to 10,000 feet (-396 meters to 3,048 meters)
Moisture Protection	IPX7: Watertight to a depth of 3 feet (0.91 meters) for up to 30 minutes
Cartridge Volume	3.0 mL or 300 units
Cannula Fill Amount	0.1 to 1.0 units of insulin
Insulin Concentration	U-100
Alarm Type	Visual, audible, and vibratory

t:slim X2 Pump Specifications (Continued)

Specification Type	Specification Details
Basal Delivery Accuracy at all Flow Rates (tested per IEC 60601-2-24)	±5% The pump is designed to vent automatically when there is a pressure difference between inside the cartridge and the surrounding air. In certain conditions, such as a gradual elevation change of 1,000 feet (305 meters), the pump may not vent immediately and delivery accuracy can vary up to 15% until 3 units have been delivered or elevation changes by more than 1,000 feet (305 meters).
Bolus Delivery Accuracy at all Volumes (tested per IEC 60601-2-24)	±5%
Patient Protection from Air Infusion	The pump provides subcutaneous delivery into interstitial tissue and does not deliver intravenous injections. Clear tubing aids in detecting air.
Maximum Infusion Pressure Generated and Occlusion Alarm Threshold	30 PSI
Frequency of Basal Delivery	5 minutes for all Basal Rates
Retention Time of Electronic Memory when Internal System Battery is Fully Discharged (including Alarm Settings and Alarm History)	Greater than 30 days
Infusion Set used for Testing	Unomedical Comfort™ Infusion Set
Typical Operating Time when System is Operating at Intermediate Rate	During normal use, the intermediate rate is 2 units/hr; battery charge can be reasonably expected to last up to between 4 and 7 days depending on your use of CGM features from a fully charged state to a totally discharged state

t:slim X2 Pump Specifications (Continued)

Specification Type	Specification Details
Handling of Over-Infusion or Under-Infusion	<p>The method of delivery isolates the insulin chamber from the patient and the software performs frequent monitoring of system status. Multiple software monitors provide redundant protection against unsafe conditions.</p> <p>Over-infusion is mitigated by continuous self-tests, layering of redundancies and confirmations, and numerous other safeguard alarms. Users are required to review and confirm the details of all bolus deliveries, basal rates, and temp rates to ensure certainty before initiating a delivery. In addition, once bolus deliveries are confirmed, the user is given 5 seconds to cancel the delivery before it is started. An optional Auto-Off alarm triggers when the user has not interacted with the pump's user interface for a predefined period of time.</p> <p>Under-infusion is mitigated by occlusion detection and BG monitoring as BG entries are recorded. Users are prompted to treat high BG conditions with a correction bolus.</p>
Bolus Volume at Release of Occlusion (2 units per hour Basal)	Less than 3 units with Unomedical Comfort (110cm) Infusion Set
Residual Insulin Remaining in the Cartridge (unusable)	Approximately 15 units
Minimum Audible Alarm Volume	45 dBA at 1 meter

NOTE

Accuracies stated in this table are valid for all Tandem Diabetes Care, Inc. branded infusion sets including: AutoSoft™ 90, AutoSoft™ XC, AutoSoft™ 30, VariSoft™, TruSteel™ branded infusion sets.

USB Charging/Download Cable Specifications

Specification Type	Specification Detail
Tandem P/N	004113
Length	6 feet (2 meters)
Type	USB A to USB Micro B

Power Supply/Charger, AC, Wall Mount, USB Specifications

Specification Type	Specification Detail
Tandem P/N	007866
Input	100 to 240 Volts AC, 50/60 Hz
Output Voltage	5 Volts DC
Max Output Power	5 Watts
Output Connector	USB type A

PC, USB Connector, Specifications

Specification Type	Specification Detail
Output Voltage	5 Volts DC
Output Connector	USB type A
Safety Standard Compliance	60950-1 or 60601-1 or equivalent

Requirements for Charging from a Computer

The t:slim X2 pump is designed to be connected to a host computer for battery charging and data transfer. The following minimum characteristics are required of the host computer:

- USB 1.1 port (or later)
- Computer compliant with 60950-1 or equivalent safety standard

Connecting the pump to a host computer that is attached to other equipment could result in previously unidentified risks to the patient, operator, or a third party. The user should identify, analyze, evaluate, and control these risks.

Subsequent changes to the host computer could introduce new risks and require additional analysis. These changes can include but are not limited to changing the configuration of the computer, connecting additional items to the computer, disconnecting items from the computer, and updating or upgrading equipment connected to the computer.

33.3 t:slim X2 Pump Options and Settings

t:slim X2 Pump Options and Settings

Option/Setting Type	Option/Setting Detail
Time	May be set to 12-hour or 24-hour clock (default is 12-hour clock)
Basal Rate Setting Range	0.1 – 15 units/hr
Insulin Delivery Profiles (Basal and Bolus)	6
Basal Rate Segments	16 per delivery profile
Basal Rate Increment	0.001 at programmed rates equal to or greater than 0.1 units/hr
Temp Basal Rate	15 minutes to 72 hours with 1 minute resolution with a range of 0% to 250%
Bolus Setup	Can deliver based on carb input (grams) or insulin input (units). The range for carbs is 1 to 999 grams, the range for insulin is 0.05 to 25 units
Insulin-to-Carb (IC) Ratio	16 time segments per 24-hour period; Ratio: 1 unit of insulin per x grams of carbs; 1:1 to 1:300 (can be set by 0.1 below 10)
BG Correction Target Value	16 time segments. 70 to 250 mg/dL in 1 mg/dL increments
Correction Factor	16 time segments; Ratio: 1 unit of insulin reduces BG x mg/dL; 1:1 to 1:600 (1 mg/dL increments)
Duration of Insulin Action	1 time segment; 2 to 8 hours in 1-minute increments (default is 5 hrs)
Bolus Increment	0.01 at volumes greater than 0.05 units
Quick Bolus Increments	When set to units: 0.5, 1, 2, 5 units (default is 0.5 units); or when set to grams/carbs: 2, 5, 10, 15 grams (default is 2 g)

t:slim X2 Pump Options and Settings (Continued)

Option/Setting Type	Option/Setting Detail
Maximum Extended Bolus Time	8 hours
Maximum Bolus Size	25 units
Low Cartridge Volume Indicator	Status indicator visible on <i>Home</i> screen; Low Insulin Alert is user adjustable from 10 to 40 units (default is 20 units).
Auto-Off Alarm	On or Off (default is on); user-adjustable (5 to 24 hours; default is 12 hours, which you can change when option is set to on).
History Storage	At least 90 days of data
Language	Dependent on region of use. May be set to English, Czech, Danish, Dutch, Finnish, French, German, Italian, Norwegian, Spanish, or Swedish (default is English).
Security PIN	Protects from unintentional access, and blocks access to quick bolus when enabled (default is off).
Screen Lock	Protects from unintentional screen interactions.
Site Reminder	Prompts user to change infusion set. Can be set for 1 to 3 days at a time selected by user (default is off).
Missed Meal Bolus Reminder	Prompts user if a bolus has not occurred during the period of time the reminder is set for. 4 reminders available (default is off).
After Bolus Reminder	Prompts user to test BG at a selected time period after a Bolus has been delivered. Can be set between 1 to 3 hours (default is off).
High BG Reminder	Prompts user to retest BG after a High BG has been entered. User selects High BG value and time for reminder. (default is off).
Low BG Reminder	Prompts user to retest BG after a Low BG has been entered. User selects Low BG value and time for reminder. (default is off).

33.4 t:slim X2 Pump Performance Characteristics

The t:slim X2 insulin pump delivers insulin in two ways: basal insulin delivery (continuous) and bolus insulin delivery. The following accuracy data was collected on both types of delivery in laboratory studies performed by Tandem.

Basal Delivery

To assess basal delivery accuracy, 32 t:slim X2 pumps were tested by delivering at low, medium, and high basal rates (0.1, 2.0, and 15 U/hr). Sixteen of the pumps were new, and 16 had been aged to simulate four years of regular use. For both aged and unaged pumps, eight pumps were tested with a new cartridge, and eight with a cartridge which underwent two years of real time aging. Water was used as a substitute for insulin. The water was pumped into a container on a scale and the weight of the liquid at various time points was used to assess pumping accuracy.

The following tables report the typical basal performance (median) observed, along with the lowest and highest results observed for low, medium, and high basal rate settings for all pumps tested. For the medium and high basal rates, accuracy is reported from the time basal delivery started with no warm-up period. For the minimum basal rate, accuracy is reported after a 1-hour warm-up period. For each time period, the tables show the volume of insulin requested in the first row and the volume that was delivered as measured by the scale in the second row.

Low Basal Rate Delivery Performance (0.1 U/hr)

Basal Duration (Number of Units Delivered with 0.1 U/hr Setting)	1 hour (0.1 U)	6 hours (0.6 U)	12 hours (1.2 U)
Amount Delivered [min, max]	0.12 U [0.09, 0.16]	0.67 U [0.56, 0.76]	1.24 U [1.04, 1.48]

Medium Basal Rate Delivery Performance (2.0 U/hr)

Basal Duration (Number of Units Delivered with 2 U/hr Setting)	1 hour (2 U)	6 hours (12 U)	12 hours (24 U)
Amount Delivered [min, max]	2.1 U [2.1, 2.2]	12.4 U [12.0, 12.8]	24.3 U [22.0, 24.9]

High Basal Rate Delivery Performance (15 U/hr)

Basal Duration (Number of Units Delivered with 15 U/hr Setting)	1 hour (15 U)	6 hours (90 U)	12 hours (180 U)
Amount Delivered [min, max]	15.4 U [14.7, 15.7]	90.4 U [86.6, 93.0]	181 U [175.0, 187.0]

Bolus Delivery

To assess bolus delivery accuracy, 32 t:slim X2 pumps were tested by delivering consecutive low, medium, and high bolus volumes (0.05, 2.5, and 25 units). Sixteen of the pumps were new, and 16 had been aged to simulate four years of regular use. For both aged and unaged pumps, eight pumps were tested with a new cartridge, and eight with a cartridge which underwent two years of real time aging. Water was used as a substitute for insulin for this testing. The water was pumped into a container on a scale, and the weight of the liquid at various time points was used to assess pumping accuracy.

Delivered bolus volumes were compared to the requested bolus volume delivery for minimum, intermediate, and maximum bolus volumes. The tables below show average, minimum and maximum bolus sizes observed as well as the number of boluses which were observed to be within the specified range of each target bolus volume.

Summary of Bolus Delivery Performance (n=32 pumps)

Individual Bolus Accuracy Performance	Target Bolus Size [Units]	Mean Bolus Size [Units]	Min Bolus Size [Units]	Max Bolus Size [Units]
Min Bolus Delivery Performance (n=800 boluses)	0.050	0.050	0.000	0.114
Intermediate Bolus Delivery Performance (n=800 boluses)	2.50	2.46	0.00	2.70
Max Bolus Delivery Performance (n=256 boluses)	25.00	25.03	22.43	25.91

Low Bolus Delivery Performance (0.05U) (n=800 boluses)

	Units of Insulin Delivered After a 0.05 U Bolus Request									
	<0.0125 (<25%)	0.0125– 0.0375 (25–75%)	0.0375– 0.045 (75–90%)	0.045– 0.0475 (90–95%)	0.0475– 0.0525 (95–105%)	0.0525– 0.055 (105–110%)	0.055– 0.0625 (110–125%)	0.0625– 0.0875 (125–175%)	0.0875– 0.125 (175–250%)	>0.125 (>250%)
Number and Percent of Boluses Within Range	21/800 (2.6%)	79/800 (9.9%)	63/800 (7.9%)	34/800 (4.3%)	272/800 (34.0%)	180/800 (22.5%)	105/800 (13.1%)	29/800 (3.6%)	17/800 (2.1%)	0/800 (0.0%)

Intermediate Bolus Delivery Performance (2.5U) (n=800 boluses)

	Units of Insulin Delivered After a 2.5 U Bolus Request									
	<0.625 (<25%)	0.625– 1.875 (25–75%)	1.875– 2.25 (75–90%)	2.25– 2.375 (90–95%)	2.375– 2.625 (95–105%)	2.625– 2.75 (105–110%)	2.75– 3.125 (110–125%)	3.125– 4.375 (125–175%)	4.375– 6.25 (175–250%)	>6.25 (>250%)
Number and Percent of Boluses Within Range	9/800 (1.1%)	14/800 (1.8%)	11/800 (1.4%)	8/800 (1.0%)	753/800 (94.1%)	5/800 (0.6%)	0/800 (0.0%)	0/800 (0.0%)	0/800 (0.0%)	0/800 (0.0%)

High Bolus Delivery Performance (25U) (n=256 boluses)

	Units of Insulin Delivered After a 25 U Bolus Request									
	<6.25 (<25%)	6.25– 18.75 (25–75%)	18.75– 22.5 (75–90%)	22.5– 23.75 (90–95%)	23.75– 26.25 (95–105%)	26.25– 27.5 (105–110%)	27.5– 31.25 (110–125%)	31.25– 43.75 (125–175%)	43.75– 62.5 (175–250%)	>62.5 (>250%)
Number and Percent of Boluses Within Range	0/256 (0.0%)	0/256 (0.0%)	1/256 (0.4%)	3/256 (1.2%)	252/256 (98.4%)	0/256 (0.0%)	0/256 (0.0%)	0/256 (0.0%)	0/256 (0.0%)	0/256 (0.0%)

Rate of Delivery

Characteristic	Value
25 Unit Bolus Delivery Speed	2.97 Units/min Typical
2.5 Unit Bolus Delivery Speed	1.43 Units/min Typical
20 Unit Prime	9.88 Units/min Typical

Bolus Duration

Characteristic	Value
25 Unit Bolus Duration	8 minutes 26 seconds Typical
2.5 Unit Bolus Duration	1 minute 45 seconds Typical

Time to Occlusion Alarm*

Operating Rate	Typical	Maximum
Bolus (3 units or Greater)	1 minute 2 seconds	3 Minutes
Basal (2 units/hr)	1 Hour 4 Minutes	2 Hours
Basal (0.1 units/hr)	19 Hours 43 Minutes	36 Hours

**The time to occlusion alarm is based on insulin volume not delivered. During an occlusion event, boluses of less than 3 units may not trigger an occlusion alarm if no basal insulin is being delivered. The bolus amount will reduce the time to occlusion depending on the basal rate.*

33.5 Electromagnetic Compatibility

The information contained in this section is specific to the System. This information provides reasonable assurance of normal operation, but does not guarantee such under all conditions. If the System must be used in close proximity with other electrical equipment, the System should be observed in this environment to verify normal operation. Special precautions for electromagnetic compatibility must be taken when using medical electrical equipment. The System shall be placed into service with adherence to the EMC information provided here.

▲ WARNING

Use of accessories, cables, adapters, and chargers other than those specified or provided by the manufacturer of this equipment could result in increased electromagnetic emissions or decreased electromagnetic immunity of this equipment and result in improper operation.

For IEC 60601-1 testing, Essential Performance for the System is defined as follows:

- The System will not over deliver a clinically significant amount of insulin.
- The System will not under deliver a clinically significant amount of insulin without notification to the user.
- The System will not deliver a clinically significant amount of insulin after occlusion release.
- The System will not discontinue reporting CGM data without notification to the user.

This section contains the following tables of information:

- Electromagnetic Emissions
- Electromagnetic Immunity
- Wireless Technology

33.6 Wireless Co-existence and Data Security

The System is designed to work safely and effectively in the presence of wireless devices typically found at home, work, retail stores, and places of leisure where daily activities occur.

▲ WARNING

Portable RF communications equipment (including peripherals such as antenna cables and external antennas) should be used no closer than 12 inches to any part of the t:slim X2 pump, including cables specified by the manufacturer. Otherwise, degradation of the performance of this equipment could result.

The System is designed to send and accept Bluetooth wireless technology communication. Communication is not established until you enter the appropriate credentials into your pump.

The System and system components are designed to ensure data security and patient confidentiality using a series of cybersecurity measures, including device authentication, message encryption, and message validation.

33.7 Electromagnetic Emissions

The System is intended for use in the electromagnetic environment specified below. Always make sure that the System is used in such an environment.

Guidance and Manufacturer's Declaration – Electromagnetic Emissions

Emissions Test	Compliance	Electromagnetic Environment – Guidance
RF Emissions, CISPR 11	Group 1	The System uses RF energy only for its internal function. Therefore, its RF emissions are very low and are not likely to cause any interference in nearby electronic equipment.
RF Emissions, CISPR 11	Class B	The System is suitable for use in all establishments, including domestic establishments and those directly connected to the public low-voltage power supply network that supplies buildings used for domestic purposes.
Harmonic Emissions, IEC 61000-3-2	N/A	
Voltage Fluctuations/Flicker Emissions, IEC 61000-3-3	N/A	

33.8 Electromagnetic Immunity

The System is intended for use in home healthcare electromagnetic environments.

Guidance and Manufacturer's Declaration – Electromagnetic Immunity

Immunity Test	IEC 60601 Test Level	Compliance Level
Electrostatic Discharge (ESD) IEC 61000-4-2	± 8 kV contact ± 15 kV air	± 8 kV contact ± 15 kV air
Electrical Fast Transient/burst IEC 61000-4-4	± 2 kV for power supply lines ± 1 kV for input/ output lines (100 kHz repetition frequency)	± 2 kV for power supply lines ± 1 kV for input/output lines (100 kHz repetition frequency)
Surge IEC 61000-4-5	± 1 kV differential mode ± 2 kV common mode	± 1 kV differential mode ± 2 kV common mode
Conducted RF IEC 61000-4-6	3 Vrms 150 kHz to 80 MHz	10 Vrms
Radiated RF IEC 61000-4-3	10 V/m 80 MHz to 2.7 GHz	10 V/m

Guidance and Manufacturer's Declaration – Electromagnetic Immunity (Continued)

Immunity Test	IEC 60601 Test Level	Compliance Level
Proximity Field from Wireless Transmitters	385 MHz: 27 V/m @ 18 Hz Pulse modulation 450 MHz: 28 V/m @ FM modulation 710 MHz, 745 MHz, 780 MHz: 9 V/m @ 217 Hz Pulse modulation 810 MHz, 870 MHz, 930 MHz: 28 V/m @ 18 Hz Pulse modulation 1720 MHz, 1845 MHz, 1970 MHz: 28 V/m @ 217 Hz Pulse Modulation 2450 MHz: 28 V/m @ 217 Hz Pulse modulation 5240 MHz, 5500 MHz, 5785 MHz: 9 V/m @ 217 Hz Pulse modulation	385 MHz: 27 V/m @ 18 Hz Pulse modulation 450 MHz: 28 V/m @ FM modulation 710 MHz, 745 MHz, 780 MHz: 9 V/m @ 217 Hz Pulse modulation 810 MHz, 870 MHz, 930 MHz: 28 V/m @ 18 Hz Pulse modulation 1720 MHz, 1845 MHz, 1970 MHz: 28 V/m @ 217 Hz Pulse Modulation 2450 MHz: 28 V/m @ 217 Hz Pulse modulation 5240 MHz, 5500 MHz, 5785 MHz: 9 V/m @ 217 Hz Pulse modulation
Voltage Dips, Short Interruptions, and Voltage Variations on Power Supply Input Lines IEC 61000-4-11	70% UR (30% dip in Ur) for 25 cycles 0% Ur (100% dip in Ur) for 1 cycle at 0 degrees 0% Ur (100% dip in Ur) for 0.5 cycles at 0, 45, 90, 135, 180, 225, 270, and 315 degrees 0% Ur (100% dip in Ur) for 250 cycles	70% UR (30% dip in Ur) for 25 cycles 0% Ur (100% dip in Ur) for 1 cycle at 0 degrees 0% Ur (100% dip in Ur) for 0.5 cycles at 0, 45, 90, 135, 180, 225, 270, and 315 degrees 0% Ur (100% dip in Ur) for 250 cycles
Power Frequency (50/60 Hz) Magnetic Field IEC 61000-4-8	30 A/m	400 A/m (IEC 60601-2-24)

33.9 Quality of Wireless Service

The quality of wireless service between the pump and CGM is defined as the percent of CGM readings successfully received by the pump. One of the System's essential performance requirements states that the System will not discontinue reporting data and/or information from the CGM transmitter to the user without notification.

The System notifies the user of a missed reading, or when the CGM and pump are out of range of one another in several ways. The first is when a dot is missed on the CGM graph which will occur within five minutes of the previous reading. The second indication occurs after 10 minutes when the Out of Range Icon is displayed on the *Home* screen. The third is a user settable alert that will notify the user when the pump and CGM transmitter is out of range of one another. Setting this alert is defined in [Section 21.6 Setting Your Out of Range Alert](#).

The minimum quality of wireless service of the pump and CGM assures that 90% of CGM readings will be

successfully transferred to the display while the transmitter and display are within 20 feet (6 meters) of each other, and no more than 12 consecutive readings (1 hour) will be missed.

To improve quality of service when other devices operating in the 2.4 GHz band are around, the t:slim X2 insulin pump uses the built-in coexistence features provided by Bluetooth wireless technology.

33.10 Wireless Technology

The t:slim X2 utilizes wireless technology with the following characteristics:

Wireless Technology Specifications

Specification Type	Specification Detail
Wireless Technology	Bluetooth Low Energy (BLE) version 5.0
Tx/Rx Frequency Range	2.360 to 2.500 GHz
Bandwidth (per channel)	2 MHz
Radiated Output Power (maximum)	+8 dBm
Modulation	Gaussian Frequency-Shift Keying
Data Rate	2 Mbps
Data Communication Range (maximum)	20 feet

33.11 FCC Notice Concerning Interference

The transmitter covered by this User Guide has been certified under FCC ID: PH29433.

Although the transmitter has been approved by the United States Federal Communications Commission, there is no guarantee that it will not receive interference or that any particular transmission from the transmitter will be free from interference.

Compliance Statement (Part 15.19)

This device complies with Part 15 of the FCC Rules.

Operation is subject to the following two conditions:

1. This device may not cause harmful interference, and
2. This device must accept any interference received, including interference that may cause undesired operation.

Warning (Part 15.21)

Changes or modifications not expressly approved by the party responsible for compliance could void the user's authority to operate the equipment.

FCC Interference Statement (Part 15.105 (b))

This equipment has been tested and found to comply with the limits for a Class B digital device, pursuant to Part 15 of the FCC Rules. These limits are designed to provide reasonable protection against harmful interference in a residential installation. This equipment generates uses and can radiate radio frequency energy and, if not installed and used in accordance with the instructions, may cause harmful interference to radio communications. However, there is no guarantee that interference will not occur in a particular installation. If this equipment does cause harmful interference to radio or television reception, which can be determined by turning the equipment off and on, the user is encouraged to try to correct the interference by one of the following measures:

- Reorient or relocate the receiving antenna.
- Increase the separation between the equipment and receiver.
- Connect the equipment into an outlet on a circuit different from that to which the receiver is connected.
- Consult the dealer or an experienced radio/TV technician for help.

This portable transmitter with its antenna complies with FCC/IC RF exposure limits for general population/uncontrolled exposure.

33.12 Warranty Information

Warranty t:slim X2 Insulin Pump

This warranty is valid only in the United States.

Tandem Diabetes Care, Inc. ("Tandem") warrants the t:slim X2 insulin pump against defects in materials and workmanship, under normal use, for the period of 4 years from the original date of shipment of the pump to the

original end use purchaser (the “Warranty Period”). For any defective t:slim X2 pump covered by the foregoing warranty, Tandem will, at its discretion, repair the pump or replace it with a new or refurbished t:slim X2 pump, subject to the conditions and exclusions stated herein. Repair or replacement of a t:slim X2 pump will not extend the original 4 year warranty, which will continue to apply. If your t:slim X2 pump is replaced, then you must return your original pump to Tandem in accordance with Tandem’s instructions. In the event the defective t:slim X2 pump is not returned, then this warranty shall be void and you will not be entitled to future pump replacement or repairs.

The warranty is valid only if the t:slim X2 pump is used in accordance with Tandem’s instructions for use and this user guide and will not apply if:

- damage results from changes or modifications made to the t:slim X2 insulin pump by the user or third persons after the date of manufacture;

- damage results from service or repairs performed to any part of the t:slim X2 pump by any person or entity other than Tandem;
- the t:slim X2 pump seal is broken;
- a non-Tandem cartridge is used with the t:slim X2 pump;
- damage consists of scratches and wear to surfaces and other externally exposed parts due to wear and tear;
- damage results from an event or accident beyond the control of Tandem; or
- damage results from negligence or improper use, including but not limited to improper storage or physical abuse.

From time-to-time Tandem may offer software updates for your t:slim X2 pump to help to ensure the up-to-date functionality of your pump or software that are intended to add new features to your t:slim X2 pump. Tandem reserves the right to offer those updates,

if any, in its sole discretion either at no charge or for an additional fee to be determined at a future date. To the extent that an update is offered at no charge, it is considered to be included in the original cost of your pump. Any future software updates will be subject to your acceptance of other terms and conditions that may be applicable at that time, including additional terms that may modify or limit the terms of this Warranty.

This warranty shall be personal to the original end use purchaser. Any sale, rental or other transfer or use of the t:slim X2 pump covered by this warranty to or by a user other than the original end use purchaser shall cause this warranty to immediately terminate.

This warranty only applies to the t:slim X2 pump and does not apply to other products or accessories. This warranty is valid only in the United States. No employee of Tandem or any other party is authorized to make any warranty in addition to those made in this Warranty.

The remedies provided for in this warranty are the exclusive remedies available for any warranty claims.

Neither Tandem nor its suppliers or distributors shall be liable for losses, liabilities, claims or damages of any kind or nature whatsoever, including, without limitation, any indirect, incidental, consequential, or special damages of any kind caused by or arising out of a defect in the product. All other warranties, express or implied, are excluded, including the warranties of merchantability and fitness for a particular purpose.

Warranty

t:slim X2 3 mL Cartridges

This warranty is valid only in the United States.

Tandem Diabetes Care, Inc. (“Tandem”) warrants its cartridge against defects in materials and workmanship for one use during the period of 3 days after the individual cartridge sterile packaging has been opened, not to exceed 6 months from date of shipment of the cartridge to the end user (the “Warranty Period”). During the Warranty Period, Tandem will replace any defective cartridge, subject to the conditions and exclusions stated herein.

The warranty is valid only if the cartridges are used in accordance with the accompanying instructions for use and user guide and will not apply if:

- the cartridge has been used for more than a single-time use by a single end-user;
- damage results during the improper opening of the sterile package not in conformance with the procedures outlined in the associated instructions for use;
- the sterile package is compromised while in the control of the user by any means other than purposeful opening by the user at the time of intended product use;
- damage results from changes or modifications made to the cartridge by the user or third persons after the date of manufacture;
- damage results from service or repairs performed to any part of the cartridge by any person or entity other than Tandem;

- damage is caused by use of the cartridge with any non-Tandem insulin pump;
- damage results from an event or accident beyond the control of Tandem; or
- damage results from negligence or improper use, including but not limited to improper storage or physical abuse such as dropping or otherwise.

This warranty shall be personal to the original end use purchaser. Any sale, rental or other transfer or use of the product covered by this warranty to or by a user other than the original end use purchaser shall cause this warranty to immediately terminate. This warranty does not apply to insulin pumps and other accessories. This warranty is valid only in the United States. No employee of Tandem or any other party is authorized to make any warranty in addition to those made in this Warranty.

The remedies provided for in this warranty are the exclusive remedies available for any warranty claims.

Neither Tandem nor its suppliers or distributors shall be liable for losses, liabilities, claims or damages of any kind or nature whatsoever, including, without limitation, any indirect, incidental, consequential, or special damages of any kind caused by or arising out of a defect in the product. All other warranties, express or implied, are excluded, including the warranties of merchantability and fitness for a particular purpose.

Warranty t:lock Infusion Sets

This warranty is valid only in the United States.

Tandem Diabetes Care, Inc. (“Tandem”) warrants its infusion sets against defects in materials and workmanship for one use during the period of 3 days after the individual infusion set sterile packaging has been opened, not to exceed 6 months from date of shipment of the infusion set to the end user (the “Warranty Period”). During the Warranty Period, Tandem will replace any defective infusion set, subject to the conditions and exclusions stated herein.

The warranty is valid only if the infusion sets are used in accordance with the accompanying instructions for use and user guide provided with your insulin pump and will not apply if:

- the infusion set has been used for more than a single-time use by a single end-user;
- the sterile package is compromised while in the control of the user by any means other than purposeful opening by the user at the time of intended product use;
- damage results during the improper opening of the sterile package not in conformance with the procedures outlined in the accompanying instructions for use;
- damage results from changes or modifications made to the infusion set by the user or third persons after the date of manufacture;
- damage results from service or repairs performed to any part of the infusion set by any person or entity other than Tandem;

- damage is caused by use of the t:lock infusion set with any non-Tandem insulin pump;
- damage results from an event or accident beyond the control of Tandem; or
- damage results from negligence or improper use, including but not limited to improper storage or physical abuse such as dropping or otherwise.

This warranty shall be personal to the original end use purchaser. Any sale, rental or other transfer or use of the product covered by this warranty to or by a user other than the original end use purchaser shall cause this warranty to immediately terminate. This warranty does not apply to insulin pumps and other accessories. No employee of Tandem or any other party, including without limitation any authorized distributor, is authorized to make any warranty in addition to those made in this warranty.

The remedies provided for in this warranty are the exclusive remedies available for any warranty claims.

Neither Tandem nor its suppliers or distributors shall be liable for losses, liabilities, claims or damages of any kind or nature whatsoever, including, without limitation, any indirect, incidental, consequential, or special damages of any kind caused by or arising out of a defect in the product. All other warranties, express or implied, are excluded, including the warranties of merchantability and fitness for a particular purpose.

CGM Warranty

Tandem Diabetes Care does not sell CGM sensors or transmitters and therefore provides no warranty for CGM sensors or transmitters used with the t:slim X2 insulin pump. For more information about CGM warranty information, visit the manufacturer's website.

33.13 Returned Goods Policy

The following represents the returned goods policy applicable only to customers in the United States.

Any insulin pump product ("Pump") that was originally purchased from Tandem Diabetes Care, Inc. ("Tandem") or one of its authorized distributors within the United States may be returned to Tandem only for the following reasons: (1) during the applicable Warranty Period, if the customer experiences an issue with the Pump that is covered by the Warranty, then Tandem will repair or replace the Pump as provided under the Warranty above, or (2) during the thirty (30) day period after the shipment of the Pump, if the customer discovers that the Pump is not suited for the customer based on a valid, good faith medical reason which has been confirmed by the customer's physician, then Tandem or the authorized distributor will accept the return of the Pump and provide a refund to the customer and/or its insurance company for the amount actually paid for the Pump. Tandem will not accept or be

obligated to accept for return any Pump for any other reason. To assure prompt handling when returning a Pump, the customer must first obtain a returned materials authorization (RMA) number from Tandem's or its authorized distributor's Customer Service Department. This RMA number must be clearly written on the outer box. If Tandem provides a label, the label must be attached or taped to the outer box. If no label is provided, Tandem recommends shipping via insured ground service with a tracking number. Tandem is not responsible for lost or damaged packages.

To obtain an RMA number and shipping address, please contact Tandem Customer Technical Support. Returns pre-authorized by Tandem's authorized distributors should be sent to the distributor authorizing the return, unless other instructions are provided. Returns made without the RMA number will be returned to the customer, freight collect. This policy is subject to applicable law.

33.14 t:slim X2 Insulin Pump Event Data (Black Box)

Your t:slim X2 pump's event data is monitored and logged on the pump. The information stored on the pump may be obtained and used by Customer Technical Support for troubleshooting purposes when a pump is uploaded to a data management application that supports use of the t:slim X2 pump, or if the pump is returned for any reason. Others who may assert a legal right to know, or who obtain your consent to know such information may also have access to read and use this data.

33.15 Product List

For a complete product list, please contact Customer Technical Support.

Insulin Delivery

- t:slim X2 insulin pump with Basal-IQ™ technology
- t:case (pump cover with clip)
- t:slim X2 user guide
- USB cable
- USB charger with power plugs
- cartridge removal tool

Consumables

- cartridge
 - t:slim X2 cartridge (t:lock™ connector) with filling syringe and needle
- infusion set (all with t:lock connector)

Infusion sets are available in different cannula sizes, tubing lengths, insertion angles, and may come with or without an insertion device. Some infusion sets have a soft cannula and others and have a steel needle.

Contact Customer Technical Support for available sizes and lengths of the following infusion sets with t:lock connectors:

- AutoSoft 90 infusion set
- AutoSoft 30 infusion set

- VariSoft infusion set
- TruSteel infusion set

Optional Accessories/Replacement Parts

- t:case pump cover (black, blue, pink, purple, turquoise, olive)
- t:holster
- t:slim USB charging cable
- t:slim USB charger
- power plug for t:slim USB charger
- cartridge removal tool
- t:slim screen protector
- USB rubber door

This Page is Intentionally Left Blank

INDEX

A

AC power adapter	60
Accessories	60
Active Bolus Icon	40, 168
After Bolus BG Reminder	105
Air Bubbles	
Check Tubing	75
Removing Before Delivery	75
Airport Security	155
Alarms	107, 133
Altitude Alarm	144, 145
Cartridge Error Alarm	138
Cartridge Removal Alarm	139
Empty Cartridge Alarm	137
Low Power Alarms	136
Occlusion Alarms	141
Resume Pump Alarm	135
Screen On/Quick Bolus Button Alarm	143
Temperature Alarm	140
Time to Occlusion Alarm, Specifications	294
Alerts	107, 111, 113
Alert Icon, Where to Find	40
Alerts & Reminders	50

Basal Rate Required Alert	122
Basal-IQ, Resume Alerts	265
Basal-IQ, Suspend Alert	264
CGM Rise and Fall	188
CGM, 12 Hour Calibration Alert	213
CGM, Calibrate CGM Alert	217
CGM, Calibration Error Alert	216
CGM, Calibration Timeout Alert	215
CGM, Failed Sensor	229
CGM, Fall Alert	223, 224
CGM, High Alert	218
CGM, Incomplete Calibration Alert	214
CGM, Low Alert	219, 220
CGM, Low Transmitter Battery Alert	227
CGM, Out of Range Alert	226, 263
CGM, Rise Alert	221, 222
CGM, Second Startup Calibration Alert	212
CGM, Startup Calibration Alert	211
CGM, System Error	231
CGM, Transmitter Error	228
CGM, Unavailable	230
Connection Error Alert	129, 130
Data Error Alert	132
High Glucose Alert, Set	186
Incomplete Bolus Alert	116
Incomplete Cartridge Change Alert	118

Incomplete Fill Cannula Alert	120
Incomplete Fill Tubing Alert	119
Incomplete Load Sequence Alerts	118
Incomplete Personal Profile Alert	121
Incomplete Setting Alert	121
Incomplete Temp Rate Alert	117
Low Glucose Alert, Set	187
Low Insulin Alert	108
Low Power Alerts	114
Max Bolus Alerts	124
Max Hourly Bolus Alert	123
Min Basal Alerts	127
Out of Range Alert, Set	189
Out of Range, Set	189
Power Source Alert	131
Alternate Site BG Testing	164
Altitude	154
Altitude Alarm	144, 145
Aquatic Activities, Pump	154
Arrows	
Up/Down Arrows	48

B

Basal	34
Basal Rate Required Alert	122
Current Basal Rate	44
Delivery Accuracy	284
Frequency of Delivery	284
in Personal Profiles	82
Set a Temp Rate	86
Stop a Temp Rate	87
Temp Basal Rate	35
Timed Settings	81
Basal Rate Required Alert	122
Basal-IQ	
History	259
Overview	252
Resume Alert	248
Resume Alerts	265, 266
Status Indicators	44, 246, 258
Suspend Alert	248, 264
Turn On and Off	255
Basal-IQ Technology Safety Information	240
Battery	60
Battery Level	40, 42
Charging Tips	61
Battery, Charge	60
BG	34
High BG Reminder	104
Low BG Reminder, Set	104
Target BG	34, 80

Target BG in Personal Profiles	82
BG Reminder	105
Bluetooth	180, 295
Bolus	35, 89
Active Bolus Icon	40, 168
After Bolus BG Reminder	105
Bolus Overview	90
Bolus Screen	46
Cancel a Bolus	97
Correction Bolus	35
Delivery Accuracy	284
Extended Bolus	35, 93
Food Bolus Using Grams	93
Food Bolus Using Units	92
in Personal Profiles	83
Quick Bolus	35
Rate of Delivery Specifications	294
Stop a Bolus	97
Timed Settings	81

C

Calculation	46
Calibrate CGM Alert	217
Calibrate Your CGM	197
Calibrate, Reasons to	201

Calibration Alert, 12 Hour	213
Calibration Error Alert	216
Calibration Timeout Alert	215
Cancel a Bolus	97
Cannula	35
Cannula, Fill Cannula	77
Carb Ratio	35
in Personal Profiles	82
Timed Settings	81
Carbohydrates	35, 44
Carbs, in Personal Profiles	81
Food Bolus Using Grams	93
Food Bolus, on Bolus Screen	46
turn on in Personal Profiles	84
Carbs	35
Carbs, on Bolus Screen	46
Caring for Your Pump	151
Cartridge	69
Cartridge Tubing	42
Change Cartridge	74
Fill Cartridge	72
Load Cartridge	70, 74
Load the Cartridge	35
Cartridge Error Alarm	138
Cartridge Removal Alarm	139

Cartridge, Warranty	303
--------------------------------------	-----

CGM

12 Hour Calibration Alert	213
24 Hour Calibration Update	200
Alerts and Errors	209
Automatic Sensor Shut-Off	196
Calibrate Blood Glucose Value	200
Calibrate CGM Alert	217
Calibrate Your CGM	197
Calibration Error Alert	216
Calibration Overview	198
Calibration Prompts	166
Calibration Timeout Alert	215
CGM Alerts	185
CGM Fall Alert	223, 224
CGM High Alert	218
CGM Info	183
CGM Low Alert	219, 220
CGM Rise Alert	221, 222
CGM Settings	180
CGM System Error	231
CGM Unavailable	230
Clinical Studies, Sensor	269
Default Volume	181
End a Sensor Session	196
Enter Transmitter ID	180

Failed Sensor	229
Failed Sensor, Troubleshooting	236
High BG Alert Default	186
High BG Alert Repeat	186
High Glucose Alert, Set	186
History, View	208
Incomplete Calibration Alert	214
Low BG Repeat	187
Low Glucose Alert, Set	187
Low Transmitter Battery Alert	227
My CGM Screen	172
Out of Range Alert	226, 263
Out of Range Alert, Set	189
Out of Range/No Antenna, Troubleshooting	235
Pair Your CGM	180
Rate of Change Arrows	206
Reasons to Calibrate	201
Re-Calibrate	201
Receiver	176
Rise and Fall Alerts	188
Second Startup Calibration Alert	212
Sensor Glucose Trend Arrows	206
Sensor Glucose Trend Graphs	205
Sensor Inaccuracies, Troubleshooting	236
Sensor Startup Period	194
Set Correction Bolus	200

Set Volume	181
Start a Sensor Session	191
Start Calibration	198
Startup Calibration Alert	211
Status Symbols	166
System Overview	176
Transmitter Error	228
Transmitter ID	180
Troubleshooting	233
Unknown Sensor Reading	225
Unknown Sensor Reading, Troubleshooting	234
View Data on Pump, Overview	204
CGM Fall Alert	223, 224
CGM High Alert	218
CGM ID	180
CGM Low Alert	219, 220
CGM Rise Alert	221, 222
CGM Safety Information	158
CGM Settings	179
CGM System Error	231
CGM Unavailable	230
Charge	
AC Power Outlet	60
Car Adapter	60
Charging Tips	61

Personal Computer	61
Charge the Pump	60
Cleaning Your System	152
Colors	
Explanation of System Colors	39
Computer Charging Specifications	287
Connection Error Alert	129, 130
Contents, of System	34
Correction Bolus	35
Correction Factor	35, 81
in Personal Profiles	82
Timed Settings	81
Current Status Screen	44

D

Data Error Alert	132
Data, View CGM Overview	204
Date	
Date and Time Display	40
Edit Date	63
Default	
Auto-Off Alarm	108
Basal Temp Rate	86
CGM Default Volume	181

CGM Fall Alert	188
CGM Out of Range Alert	189
CGM Rise Alert	188
Extended Bolus	93
High BG Reminder	105
High Glucose Alert	186
Low BG Reminder	104
Low Insulin Alert	108
Quick Bolus	95
Screen Timeout	64
Site Reminder	106
Delete Personal Profile	86
Delivery Summary	102
Device Settings	52
Disconnect When Filling	75
Display Settings	64
Disposing of System Components	152

E

Edit	
Edit Date	63
Edit Time	63
Site Reminder	78
Electromagnetic Compatibility	295
Electromagnetic Emissions	296

Electromagnetic Immunity	297
Emergency Kit	21
Empty Cartridge Alarm	137
End CGM Sensor Session	196
Extended Bolus	35, 93
Default	93

F

Failed Sensor Error	229
Fall Alert, Set	189
Fill	
Fill Cannula	77
Fill Cartridge	72
Fill Port	70, 72
Fill Tubing	75

G

Grams	
Food Bolus, on Bolus Screen	46
Food Bolus, using	93

H

Healthcare Provider	31
High BG Reminder	104
History	
Basal-IQ	102, 259
CGM History	208
Pump History	102
Home Screen	42
Home Screen, Basal-IQ	246
Home Screen, CGM	170

I

Icons	
Explanation of Icons	37, 166, 242
Incomplete Bolus Alert	116
Incomplete Calibration Alert	214
Incomplete Cartridge Change Alert	118
Incomplete Fill Cannula Alert	120
Incomplete Fill Tubing Alert	119
Incomplete Load Sequence Alerts	118
Incomplete Setting Alert	121
Incomplete Temp Rate Alert	117
Indications for Use	19

Infusion Set Risks	31, 68
Infusion Site Care	68
Pediatric	20
Infusion Site Care, Pediatric	20
Insulin	
Insulin Duration	81
Insulin Level Display	76
Insulin On Board (IOB)	35, 40
Insulin On Board (IOB) Display	40
Resume Insulin Delivery	100
Stop Insulin Delivery	100
Insulin Duration, in Personal Profiles	81
Insulin on Board (IOB), in Personal Profiles	81
Interference, FCC Notice	301

K

Keypad	54
Letter Keypad	56
Number Keypad	54

L

LED	39
LED, location on Home Screen	42

Lifestyle Issues	153
Load Cartridge	70, 74
Low BG Reminder	104
Low Insulin Alert	108, 113
Low Power Alarms	136
Low Power Alerts	114
Low Transmitter Battery Alert	227

M

Maintaining Your Pump	151
Malfunction	148
Max Basal Alert	126
Max Bolus Alerts	124
Max Hourly Bolus Alert	123
Min Basal Alerts	127
Missed Meal Bolus Reminder	106
My Pump Screen	50

O

Occlusion Alarms	141
Occlusion Alarms, Specifications	294
Options Screen	48
Out of Range Alert	226, 263

Overview

CGM Overview	176
System Description	18

P

Pediatric

Important Pediatric User Information	20
Infusion Site Care	20, 68
Security PIN	20

Personal Profiles

Activate a Profile	85
Add Profiles	84
Copy an Existing	85
Create a New Profile	80
Delete a Profile	86
Edit or View	84
Personal Profiles Overview	80
Program a Personal Profile	82
Rename a Profile	85

Power Adapter, AC	60
-------------------	----

Power Source Alert	131
--------------------	-----

Pump History	102
--------------	-----

Pump History, Delivery Summary	102
--------------------------------	-----

Pump Info	102
-----------	-----

Pump Info, Serial Number	102
--------------------------	-----

Pump Performance, Specifications	290
Pump Settings, Specifications	288
Pump Specifications	283

Q

Quick Bolus	20, 35, 95
Pediatric	20

R

Receiver, CGM	176
Reminder	
Site Reminder	78
Reminders	103
Alerts & Reminders	50
High BG	104
Low BG	104
Missed Meal Bolus	106
Site Reminder	106
Resume Alert	
Basal-IQ	248
Resume Alerts	
Basal-IQ	265, 266
Resume Insulin Delivery	100

Resume Pump Alarm	135
Returned Goods Policy	305
Rise Alert, Set	188
Risks from Using the System	31, 161

S

Safety Information	24, 157, 239, 281
CGM	158
Emergency Kit	21
Verification of Proper Functionality	32
Screen On/Quick Bolus Button Alarm	143
Screen Protector	34
Screen Timeout, set	64
Screens	
Basal-IQ Home Screen	246
Basal-IQ Screen Lock	244
Basal-IQ Status Screen	44
Bolus Screen	46
CGM Home Screen	170
CGM Screen Lock	168
Current Status Screen	44
Device Settings	52
Home Screen	42
Letter Keypad Screen	56
My CGM Screen	172

My Pump Screen	50	Serial Number	16, 102
Number Keypad Screen	54	Set CGM Volume	181
Options Screen	48	Settings, Pump Setting Specifications	288
Screen Lock	40	Site Reminder	
Unlock	62	Set Site Reminder	106
Second Startup Calibration Alert, CGM	212	Site Reminder, Set	78
Security PIN	65	Sound	65
Pediatric	20	Specifications	
Sensor		Computer Charging	287
Applicator	164	Electromagnetic Compatibility	295
Automatic Shut-Off	196	Electromagnetic Emissions	296
Calibration Update	200	Electromagnetic Immunity	297
CGM Clinical Studies	269	Pump	283
Failed Sensor, Troubleshooting	236	Pump Performance	290
Out of Range Alert	226, 263	Time to Occlusion Alarm	294
Out of Range/No Antenna, Troubleshooting	235	USB Cable	286
Reasons to Calibrate	201	Water Resistance	283
Re-Calibrate	201	Start a CGM Sensor Session	191
Troubleshooting	233	Startup Calibration Alert	211
Troubleshooting Sensor Reading	234	Stop a Bolus	97
Unknown Reading	225	Stop a Temp Rate	87
Sensor Glucose Rate of Change Arrows	206	Stop CGM Sensor Session	196
Sensor Glucose Trend Graphs	205	Stop Insulin Delivery	100
Sensor Startup Period	194	Storing Your System	152
Sensor, Start a Session	192	Supply Reordering	34
Sensor, Start Calibration	198		

Symbols, Explanation of	16
System Contents	34

T

Tandem Logo	42, 62
Target BG	34
in Personal Profiles	82
Target BG, in Personal Profiles	80
Timed Settings	81
Temp Rate	
Stop a Temp Rate	87
Temp Rate, Set a Temp Basal Rate	86
Temperature Alarm	140
Temperature, Extreme	154
Time	
Date and Time Display	40
Edit Time	63
Time Segments	80
Time Segments, in Personal Profiles	82
Time Segments	
add to Personal Profile	83
Time to Occlusion Alarm, Specifications	294
Timed Settings	81
in Personal Profiles	82

Transmitter Error	228
Transmitter ID	180
Travel	155
Traveling With Your Pump	153
Traveling, by Air	155
Trend Graphs, Sensor Glucose Trends, Arrows	205
Troubleshooting CGM	233
Tubing	
Cartridge Tubing	42
Fill Tubing	75
Tubing Connector	42, 70, 76

U

Units	36
Food Bolus, on Bolus Screen	46
Food Bolus, Using Units	92
Units, on Bolus Screen	46
Unknown Sensor Reading	225
Unlock the Screen	62
USB	
Cable Specifications	286
USB Adapter	60
USB Cable	34, 60
USB Port	42, 60

V

Verification of Proper Functionality	32
View Calculation	46
Volume	65

W

Warranty	
Cartridges	303
Pump Warranty	301
Water Resistance, Pump	154
Watertight, Pump	154

Covered by one or more patents. For a list of patents, see tandemdiabetes.com/legal/patents.

Tandem Diabetes Care, the Tandem Diabetes Care logo, t:slim X2, t:lock, Basal-IQ, AutoSoft, TruSteel, and VariSoft are trademarks of Tandem Diabetes Care, Inc. Dexcom and Dexcom G6 are either registered trademarks or trademarks of Dexcom, Inc. in the U.S. and/or other countries. The Bluetooth® word mark and logos are registered trademarks owned by Bluetooth SIG, Inc. and any use of such marks by Tandem Diabetes Care, Inc. is under license. All other trademarks and copyrights are the property of their respective owners.

R_x Only



UNITED STATES:

(877) 801-6901
tandemdiabetes.com

CANADA:

(833) 509-3598
tandemdiabetes.ca

OTHER COUNTRIES:

tandemdiabetes.com/contact



1005662_D
AW-1005663_D
2020-JAN-07